

Panasonic

Panasonic

## HJ4-L-DC24V-D-6

Osa numero:

HJ4-L-DC24V-D-6

Valmistaja / merkki:

Panasonic

Tuotteen Kuvaus

HJ 4FORM C DC 24V

lomakkeissa:

RoHS-tila

 Lyijytön / RoHS-yhteensopiva

Varaston kunto

9249 pcs stock

Lähetys

Hong Kong

Lähetysreitti

DHL/Fedex/TNT/UPS/EMS

TARJOUSPYINTÖ

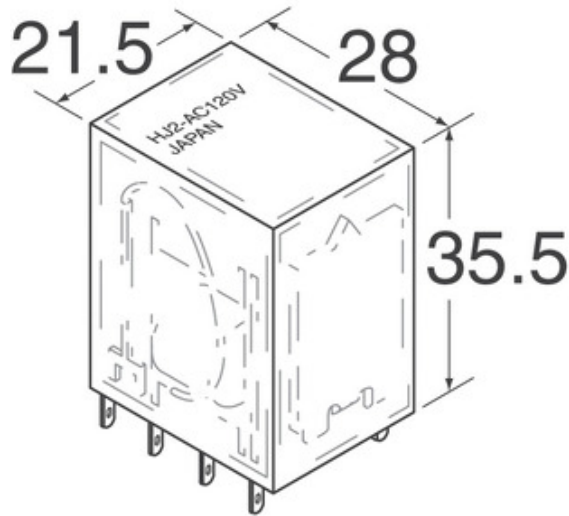

Kuva voi olla edustus. Katso tuotetiedot.













## HJ4-L-DC24V-D-6: n tekniset tiedot

OSA NUMERO	HJ4-L-DC24V-D-6
VALMISTAJA	Panasonic
KUVAUS	HJ 4FORM C DC 24V
LYIJYTÖN TILA / ROHS-TILA	Lyijytön / RoHS-yhteensopiva
SAATAVANA OLEVA MÄÄRÄ	9249 pcs
TIETOLOMAKE	
SARJA	*
KOSTEUDEN HERKKYYS (MSL)	1 (Unlimited)
LYIJYTÖN TILA / ROHS-TILA	Lead free / RoHS Compliant
YKSITYISKOHTAINEN KUVAUS	Relay Coil

## Liittyvät tunnisteet

Panasonic HJ4-L-DC24V-D-6	HJ4-L-DC24V-D-6 Jakelija	HJ4-L-DC24V-D-6-toimittaja
HJ4-L-DC24V-D-6 Hinta	HJ4-L-DC24V-D-6 Kuvat	HJ4-L-DC24V-D-6 Kuva
HJ4-L-DC24V-D-6 PDF -datata	HJ4-L-DC24V-D-6 Lataa tietosivu	HJ4-L-DC24V-D-6-tietosivu
HJ4-L-DC24V-D-6 Varasto	Osta HJ4-L-DC24V-D-6	Osta Panasonic HJ4-L-DC24V-D-6
Panasonic HJ4-L-DC24V-D-6	Panasonic toimittaja	Panasonic Jakelija
Panasonic HJ4-L-DC24V-D-6	Panasonic - Consumer Division HJ4-L-DC24V-D-6	Panasonic - Consumer Electronics Corp. HJ4-L-DC24V-D-6
Panasonic Battery Group HJ4-L-DC24V-D-6	Panasonic Electric Works - ACSD HJ4-L-DC24V-D-6	Panasonic Electronic Components - Semiconductor Pr HJ4-L-DC24V-D-6
Panasonic - ATG HJ4-L-DC24V-D-6	Panasonic - BSG HJ4-L-DC24V-D-6	Panasonic - DTG HJ4-L-DC24V-D-6
Panasonic Electric Works HJ4-L-DC24V-D-6	Panasonic Electronic Components HJ4-L-DC24V-D-6	Panasonic Industrial Automation Sales HJ4-L-DC24V-D-6
Panasonic Semiconductor HJ4-L-DC24V-D-6		

## Liittyvät tuotteet

 <p><b>HJ4-L-DC48V-6</b> valmistajat: Panasonic Kuvaus: RELAY GENERAL PURPOSE Varastossa: 6054 pcs</p> <p><b>RFQ</b></p>	 <p><b>HJ4-L-DC12V-6</b> valmistajat: Panasonic Kuvaus: RELAY GENERAL PURPOSE Varastossa: 5283 pcs</p> <p><b>RFQ</b></p>
 <p><b>HJ4-L-DC24V-D</b> valmistajat: Panasonic Kuvaus: RELAY GENERAL PURPOSE Varastossa: 6763 pcs</p> <p><b>RFQ</b></p>	 <p><b>HJ4-L-DC24V</b> valmistajat: Panasonic Kuvaus: RELAY GEN PURPOSE 4PDT 5A 24V Varastossa: 10307 pcs</p> <p><b>RFQ</b></p>
 <p><b>HJ4-L-DC48V-D-6</b> valmistajat: Panasonic Kuvaus: RELAY GENERAL PURPOSE Varastossa: 6998 pcs</p> <p><b>RFQ</b></p>	 <p><b>HJ4-L-DC48V-D</b> valmistajat: Panasonic Kuvaus: RELAY GENERAL PURPOSE Varastossa: 4072 pcs</p> <p><b>RFQ</b></p>
 <p><b>HJ4-L-DC48V</b> valmistajat: Panasonic Kuvaus: RELAY GEN PURPOSE 4PDT 5A 48V Varastossa: 11557 pcs</p> <p><b>RFQ</b></p>	 <p><b>HJ4-L-DC12V-D</b> valmistajat: Panasonic Kuvaus: RELAY GENERAL PURPOSE Varastossa: 3044 pcs</p> <p><b>RFQ</b></p>
 <p><b>HJ4-L-DC12V-D-6</b> valmistajat: Panasonic Kuvaus: RELAY GENERAL PURPOSE Varastossa: 3953 pcs</p> <p><b>RFQ</b></p>	 <p><b>HJ4-L-DC24V-6</b> valmistajat: Panasonic Kuvaus: RELAY GENERAL PURPOSE Varastossa: 3786 pcs</p> <p><b>RFQ</b></p>
 <p><b>HJ4-L-T-AC120V</b> valmistajat: Panasonic Kuvaus: RELAY GEN PURPOSE 4PDT 5A 120V Varastossa: 9348 pcs</p> <p><b>RFQ</b></p>	 <p><b>HJ4-L-T-AC100V</b> valmistajat: Panasonic Kuvaus: RELAY GEN PURPOSE 4PDT 5A 100V Varastossa: 8903 pcs</p> <p><b>RFQ</b></p>

Copyright © 2020 Elektronisten komponenttien luotettava jakelija

Sähköposti: Info@infinity-electronic.com

Osoite: 17F, Gaylord Commercial Building, 114-118 Lockhart Road, Wan Chai, Hong Kong

