





Grayhill, Inc.

## 62S11-H9-050S

Osa numero:	62S11-H9-050S
Valmistaja / merkki:	Grayhill, Inc.
Tuotteen Kuvaus	ROTARY ENCODER OPTICAL 32PPR
lomakkeissa:	 62S11-H9-050S.pdf
RoHS-tila	 Lyijytön / RoHS-yhteensopiva
Varaston kunto	1839 pcs stock
Lähetys	Hong Kong
Lähetysreitti	DHL/Fedex/TNT/UPS/EMS

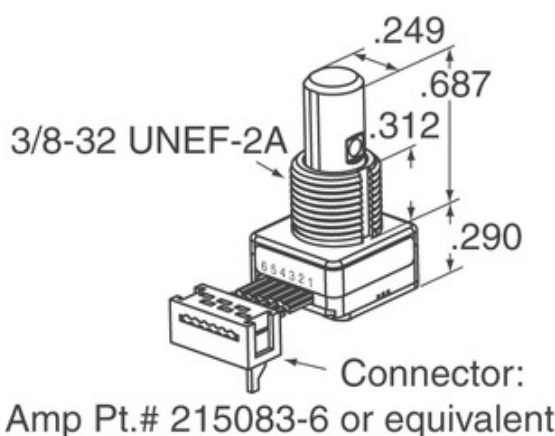
**TARJOUSPYINTÖ**

Kuva voi olla edustus. Katso tuotetiedot.

## 62S11-H9-050S: n tekniset tiedot

OSA NUMERO	62S11-H9-050S
VALMISTAJA	Grayhill, Inc.
KUVAUS	ROTARY ENCODER OPTICAL 32PPR
LYIJYTÖN TILA / ROHS-TILA	Lyijytön / RoHS-yhteensopiva
SAATAVANA OLEVA MÄÄRÄ	1839 pcs
TIELOMAKE	 62S11-H9-050S.pdf
JÄNNITE - SUPPLY	5V
PÄÄTTYMINEN STYLE	Cable Leads
SARJA	62S
PYÖRITYKSEN LIFE (CYCLES MIN)	1M
PULSSIA PER KIERROS	32
LÄHTÖ TYYPPI	Quadrature (Incremental)
MUUT NIMET	62S11H9050S
SUUNTAUTUMINEN	Vertical
ASENNUSTYYPPI	Panel Mount
KOSTEUDEN HERKKYYS (MSL)	1 (Unlimited)
LYIJYTÖN TILA / ROHS-TILA	Lead free / RoHS Compliant
ENCODER TYPE	Optical
PIDÄKKEEN	Yes
SISÄÄNRAKENNETTU KYTKIN	Yes
ACTUATOR TYPE	1/4" Dia Flatted End

**Liittyvät tunnisteet**

Grayhill, Inc. 62S11-H9-050S	62S11-H9-050S Jakelija	62S11-H9-050S-toimittaja
62S11-H9-050S Hinta	62S11-H9-050S Kuvat	62S11-H9-050S Kuva
62S11-H9-050S PDF -datata	62S11-H9-050S Lataa tietosivu	62S11-H9-050S-tietosivu
62S11-H9-050S Varasto	Osta 62S11-H9-050S	Osta Grayhill, Inc. 62S11-H9-050S
Grayhill, Inc. 62S11-H9-050S	Grayhill, Inc. toimittaja	Grayhill, Inc. Jakelija
Grayhill, Inc. 62S11-H9-050S	Grayhill Inc. 62S11-H9-050S	

**Liittyvät tuotteet**

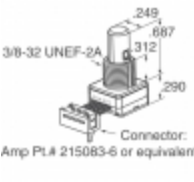
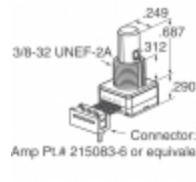
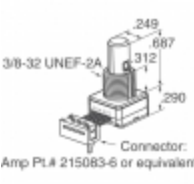
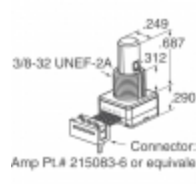
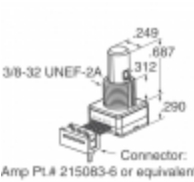
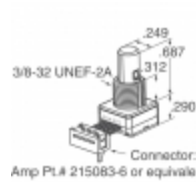
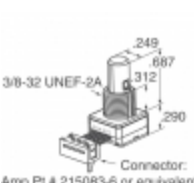
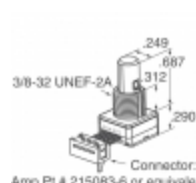
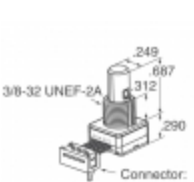
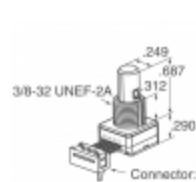
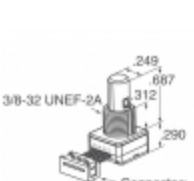
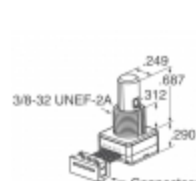
 <p><b>62S11-L0-020CH</b> valmistajat: Grayhill, Inc. Kuvaus: ROTARY ENCODER OPTICAL 32PPR Varastossa: 2105 pcs</p> <p><b>RFQ</b></p>	 <p><b>62S11-H9-PH</b> valmistajat: Grayhill, Inc. Kuvaus: ROTARY ENCODER OPTICAL 32PPR Varastossa: 2090 pcs</p> <p><b>RFQ</b></p>
 <p><b>62S11-H9-060SH</b> valmistajat: Grayhill, Inc. Kuvaus: ROTARY ENCODER OPTICAL 32PPR Varastossa: 1966 pcs</p> <p><b>RFQ</b></p>	 <p><b>62S11-H9-025S</b> valmistajat: Grayhill, Inc. Kuvaus: ROTARY ENCODER OPTICAL 32PPR Varastossa: 2155 pcs</p> <p><b>RFQ</b></p>
 <p><b>62S11-H9-020S</b> valmistajat: Grayhill, Inc. Kuvaus: ROTARY ENCODER OPTICAL 32PPR Varastossa: 2170 pcs</p> <p><b>RFQ</b></p>	 <p><b>62S11-H0-PH</b> valmistajat: Grayhill, Inc. Kuvaus: ROTARY ENCODER OPTICAL 32PPR Varastossa: 2006 pcs</p> <p><b>RFQ</b></p>
 <p><b>62S11-H9-040S</b> valmistajat: Grayhill, Inc. Kuvaus: ROTARY ENCODER OPTICAL 32PPR Varastossa: 2086 pcs</p> <p><b>RFQ</b></p>	 <p><b>62S11-H9-060C</b> valmistajat: Grayhill, Inc. Kuvaus: ROTARY ENCODER OPTICAL 32PPR Varastossa: 2172 pcs</p> <p><b>RFQ</b></p>
 <p><b>62S11-L0-020C</b> valmistajat: Grayhill, Inc. Kuvaus: ROTARY ENCODER OPTICAL 32PPR Varastossa: 1839 pcs</p> <p><b>RFQ</b></p>	 <p><b>62S11-H9-020C</b> valmistajat: Grayhill, Inc. Kuvaus: ROTARY ENCODER OPTICAL 32PPR Varastossa: 2176 pcs</p> <p><b>RFQ</b></p>
 <p><b>62S11-H9-P</b> valmistajat: Grayhill, Inc. Kuvaus: ROTARY ENCODER OPTICAL 32PPR Varastossa: 2159 pcs</p> <p><b>RFQ</b></p>	 <p><b>62S11-H9-040C</b> valmistajat: Grayhill, Inc. Kuvaus: ROTARY ENCODER OPTICAL 32PPR Varastossa: 1975 pcs</p> <p><b>RFQ</b></p>

Copyright © 2020 Elektronisten komponenttien luotettava jakelija

Sähköposti: Info@infinity-electronic.com

Osoite: 17F, Gaylord Commercial Building, 114-118 Lockhart Road, Wan Chai, Hong Kong

