

Switch - PLC-SC-S/H - 2980733

Please be informed that the data shown in this PDF Document is generated from our Online Catalog. Please find the complete data in the user's documentation. Our General Terms of Use for Downloads are valid (<http://phoenixcontact.com/download>)



PLC-RELAY with integrated switch (actuation: Manual) with screw connection, for mounting on DIN rail NS 35/7.5, input voltage ≤ 72 V DC

Product Features

- Just 6.2 mm wide
- Floating confirmation contact
- Screw, spring-cage or Push-in connection



Key Commercial Data

Packing unit	1 pc
Weight per Piece (excluding packing)	30.37 g
Custom tariff number	85364190
Country of origin	Germany

Technical data

Dimensions

Width	6.2 mm
Height	80 mm
Depth	90 mm

Ambient conditions

Ambient temperature (operation)	-20 °C ... 60 °C
Ambient temperature (storage/transport)	-40 °C ... 70 °C

Contact side

Maximum switching voltage	72 V DC
Minimum switching voltage	2 V DC

Switch - PLC-SC-S/H - 2980733

Technical data

Contact side

Min. switching current	1 mA
Maximum inrush current	50 mA

General

Operating mode	100% operating factor
Flammability rating according to UL 94	V0
Standards/regulations	IEC 60664
	EN 50178
	IEC 62103
Rated surge voltage/insulation	0.5 kV / basic insulation
Rated insulation voltage	85 V AC
Degree of pollution	2
Overvoltage category	III
Mounting position	any
Assembly instructions	In rows with zero spacing

Connection data input side

Connection name	Input side
Connection method	Screw connection
Stripping length	8 mm
Screw thread	M3
Conductor cross section solid	0.14 mm ² ... 2.5 mm ²
Conductor cross section flexible	0.14 mm ² ... 2.5 mm ²
Conductor cross section AWG	26 ... 14

Standards and Regulations

Connection in acc. with standard	CUL
Standards/regulations	IEC 60664
	EN 50178
	IEC 62103
Rated insulation voltage	85 V AC
Rated surge voltage/insulation	0.5 kV / basic insulation
Degree of pollution	2
Overvoltage category	III
Flammability rating according to UL 94	V0

Switch - PLC-SC-S/H - 2980733

Classifications

eCl@ss

eCl@ss 4.0	27371102
eCl@ss 4.1	27371102
eCl@ss 5.0	27371001
eCl@ss 5.1	27371001
eCl@ss 6.0	27371001
eCl@ss 7.0	27371001
eCl@ss 8.0	27142301

ETIM

ETIM 2.0	EC001504
ETIM 3.0	EC001504
ETIM 4.0	EC001504
ETIM 5.0	EC001545

UNSPSC

UNSPSC 6.01	30211916
UNSPSC 7.0901	39121542
UNSPSC 11	39121542
UNSPSC 12.01	39121542
UNSPSC 13.2	39121542

Approvals

Approvals

Approvals

UL Listed / cUL Listed / GL / UL Recognized / cUL Recognized / EAC / cULus Recognized / cULus Listed

Ex Approvals

Approvals submitted

Approval details

Switch - PLC-SC-S/H - 2980733

Approvals

UL Listed 



cUL Listed 

GL

UL Recognized 

cUL Recognized 

EAC

cULus Recognized  

cULus Listed 

Drawings

Switch - PLC-SC-S/H - 2980733

Circuit diagram

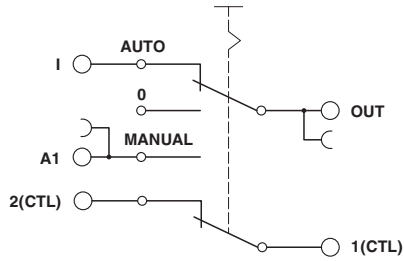

Application drawing

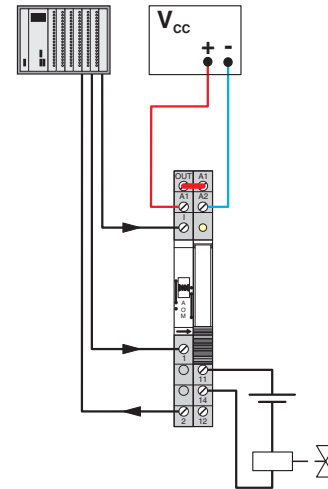

Application drawing

