



# **TFT LCD Module**

## **Product Specification**

### **DT050TFT-TS**

**5.0" (800(RGB) x 480 PIXELS) TFT Module  
with Resistive Touch Panel**

June 1, 2016

**Remark:**

Contents in this document are subject to change without notice. No part of this document may be reproduced or transmitted in any form or by any means, electronic or mechanical, for any purpose, without the express written permission of Displaytech Ltd.

**Displaytech Ltd.**

Tel: (852) 2311 2080 ; Fax: (852) 2722 6998 ; Email: [sales@displaytech.com.hk](mailto:sales@displaytech.com.hk)

Address: 31E Billion Plaza 2, No. 10 Cheung Yue Street, Cheung Sha Wan, Kowloon,  
Hong Kong.

Website: <http://www.displaytech.com.hk>

**Revision Record**

<b>REV</b>	<b>CHANGES</b>	<b>DATE</b>
0.0 (Ref 1.0 20131206)	First release	Jun 1, 2016

## Table of Content

<b>Revision Record .....</b>	<b>0</b>
<b>1. Scope .....</b>	<b>3</b>
<b>2. Application .....</b>	<b>3</b>
<b>3. General Information .....</b>	<b>3</b>
<b>4. Outline Drawing.....</b>	<b>4</b>
<b>5. Interface signals.....</b>	<b>5</b>
<b>6. Absolute Maximum Ratings.....</b>	<b>6</b>
<b>7. Electrical Specifications .....</b>	<b>6</b>
<b>8. Command/AC Timing.....</b>	<b>7</b>
<b>9. Optical Specification.....</b>	<b>11</b>
<b>10. Environmental / Reliability Tests.....</b>	<b>14</b>
<b>11. Precautions for Use of LCD Modules.....</b>	<b>14</b>

## 1. Scope

This data sheet is to introduce the specification of DT050TFT-TS, active matrix TFT module. It is composed of a color TFT-LCD panel, driver ICs, FPC, RTP, and a backlight unit. The 5.0" display area contains 800RGB x 480 pixels.

## 2. Application

Digital equipments which need color display, mobile navigator/video systems.

## 3. General Information

Item	Contents	Unit
Size	5.0	Inch
Resolution	800(RGB) x 480	
Technology Type	a-Si TFT	
Interface	RGB 24 bits	
Pixel Pitch	0.135 x 0.135	mm
Pixel Configuration	R.G.B. Vertical Stripe	
Outline Dimension (W x H x D)	120.70 x 75.80 x 4.3	mm
Active Area	108.00 x 64.80	mm
Display Mode	Transmissive, Normally white	
Backlight Type	LED	

### 4. Outline Drawing

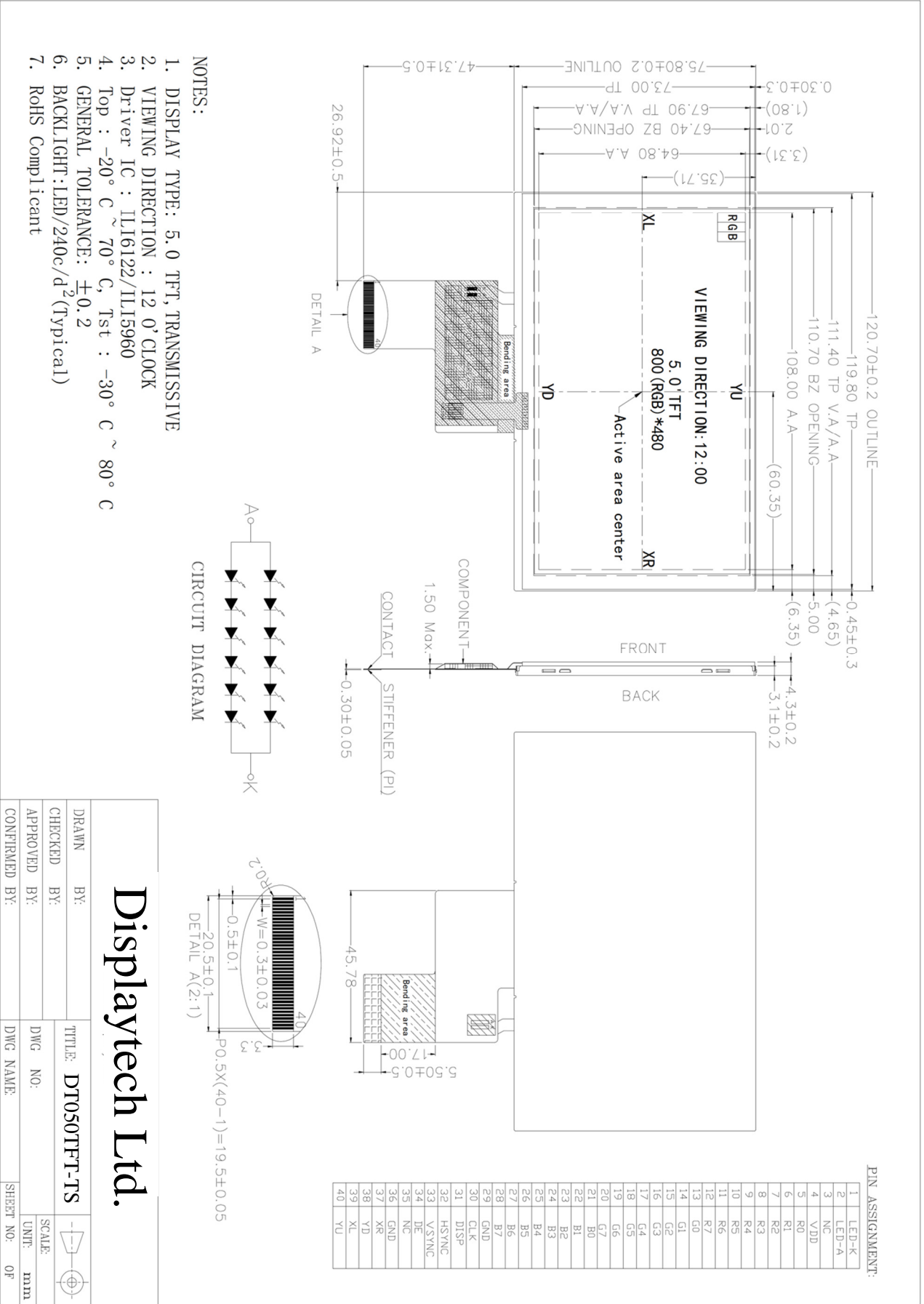

## 5. Interface signals

No	Symbol	Description	Remark
1	LED-K	Backlight LED Cathode	
2	LED-A	Backlight LED Anode	
3	NC	No connection	
4	VDD	Digital power supply	
5	R0	Red data	
6	R1	Red data	
7	R2	Red data	
8	R3	Red data	
9	R4	Red data	
10	R5	Red data	
11	R6	Red data	
12	R7	Red data	
13	G0	Green data	
14	G1	Green data	
15	G2	Green data	
16	G3	Green data	
17	G4	Green data	
18	G5	Green data	
19	G6	Green data	
20	G7	Green data	
21	B0	Blue data	
22	B1	Blue data	
23	B2	Blue data	
24	B3	Blue data	
25	B4	Blue data	
26	B5	Blue data	
27	B6	Blue data	
28	B7	Blue data	
29	GND	Power ground	
30	CLK	Clock for input data	
31	DISP	Display on/off control	
32	HSYNC	Horizontal sync signal	
33	VSYNC	Vertical sync signal	
34	DE	Data enable	
35	NC	No connection	
36	GND	Power ground	
37	XR	Touch panel right side	
38	YD	Touch panel bottom side	
39	XL	Touch panel left side	
40	YU	Touch panel up side	

## 6. Absolute Maximum Ratings

### 6.1 Electrical Absolute Max. Ratings

Item	Symbol	Min	Max	Unit	Remark
Supply voltage	VDD	-0.5	5.0	V	

### 6.2 Environment Conditions

Item	Symbol	Min	Max	Unit	Remark
Operating Temperature	TOPR	-20	70	°C	
Storage Temperature	TSTG	-30	80	°C	

### 6.3 LED Backlight Absolute Max. Ratings

Item	Symbol	Min	Max	Unit	Remark
LED forward current	ILED	--	25	mA	For each LED

## 7. Electrical Specifications

### 7.1 Electrical Characteristics

Ta=25°C

Item	Symbol	Min	Typ	Max	Unit	Remark
Digital supply voltage	VDD	3.0	3.3	3.6	V	

### 7.2 LED Backlight

Ta=25°C

Item	Symbol	Min	Typ	Max	Unit	Remark
Forward current	IF	--	40	50	mA	Note
Forward voltage	VF	--	19.8	21.0	V	
Power consumption	WBL	--	792	--	mW	
LED life time	--	--	30,000	--	Hr	

Note 1. The figure below shows the connection of backlight LED.

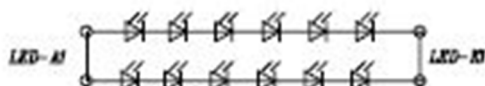

### CIRCUIT DIAGRAM

Note 2. One LED: IF=20mA, VF=3.2V

Note 3. The "LED life time" is defined as the module brightness decrease to 50% original brightness at Ta=25°C and IL=40mA. The LED lifetime could be decreased if operating IL is larger than 40mA.

## 8. Command/AC Timing

### 8.1 TFT-LCD Input Timing

VCC=3.3V, AVDD=12.61V, AGND=GND=0V, Ta=25°C

Parameter	Symbol	Min	Typ	Max	Unit	Conditions
DCLK Frequency	Fclk	-	30.0	50.0	MHz	
DCLK Cycle Time	Tcph	20	33.3	-	ns	
DCLK Pulse Width	Tcw	40%	50%	60%	Tcph	
VSD Setup Time	Tvst	8	-	-	ns	
VSD Hold Time	Tvhd	8	-	-	ns	
HSD Setup Time	Thst	8	-	-	ns	
HSD Hold Time	Thhd	8	-	-	ns	
Data Setup Time	Tdsu	8	-	-	ns	Data to DCLK
Data Hold Time	Tdhd	8	-	-	ns	Data to DCLK
DE Setup Time	Tesu	8	-	-	ns	
DE Hold Time	Tehd	8	-	-	ns	

Input Clock and Data timing Diagram:

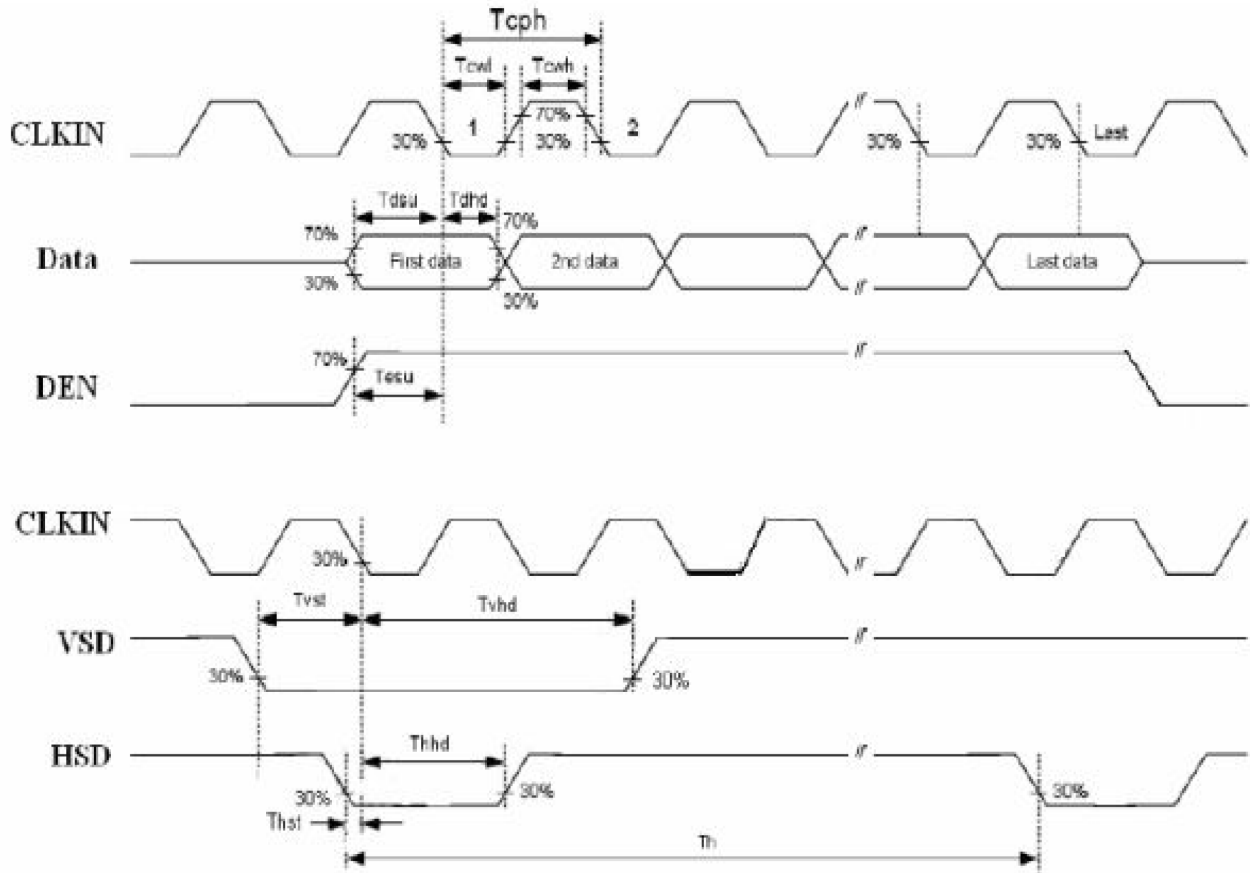



### 8.2 Recommended Timing Setting of TCON

TCON (Embedded In Source IC ) Input Timing (DCLK, HSD, VSD, ED)

VCC=3.3V, AVDD=12.61V, AGND=GND=0V, Ta=25°C

Parameter	Symbol	Min	Typ	Max	Unit	Remark
DCLK	Fclk	-	30	50	MHZ	
	tclk	-	33.3	-	ns	
HSD	th	889	928	1143	tclk	
	thd	-	800	-	tclk	
	thpw	1	48	255	tclk	
	thb	-	88	-	tclk	
	thfp	1	40	255	tclk	
VSD	tv	513	525	767	th	
	tvd	-	480	-	th	
	tvpw	3	3	255	th	
	tvb	-	32	-	th	
	tvfp	1	13	255	th	

Note: DE timing refer to HSD, VSD input timing.

Vertical input timing Diagram:

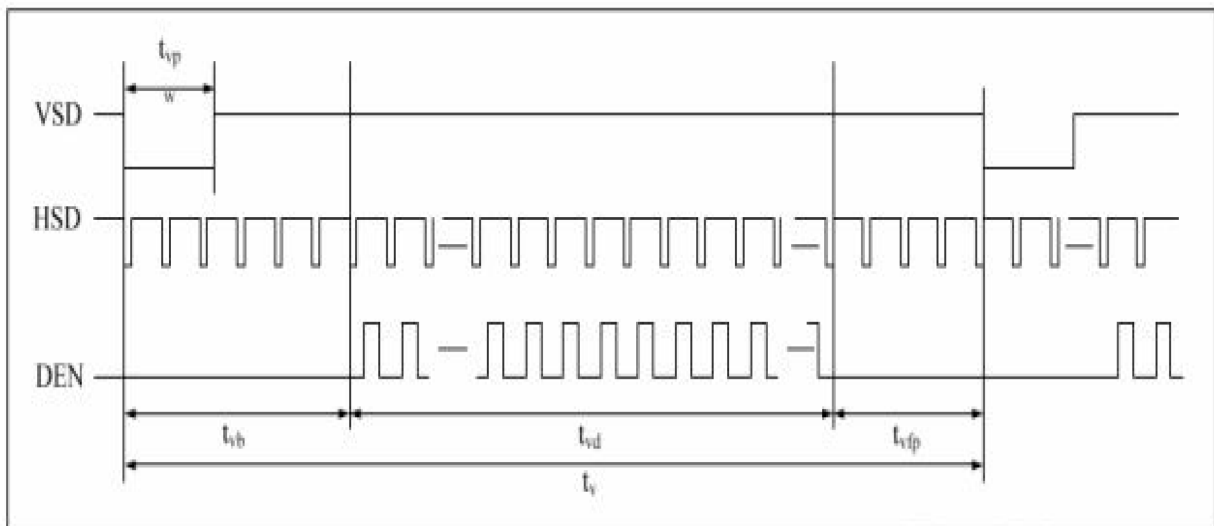

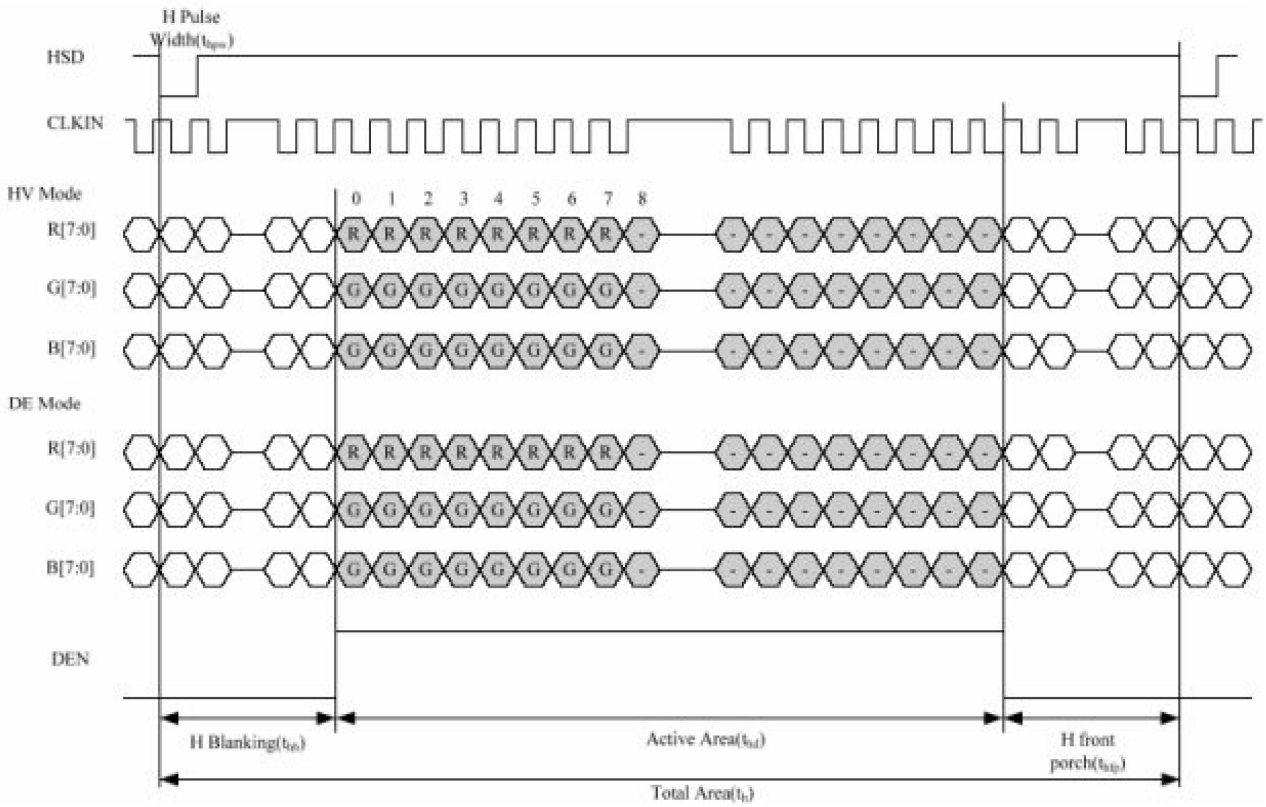

### 8.3 Power On/Off Sequence

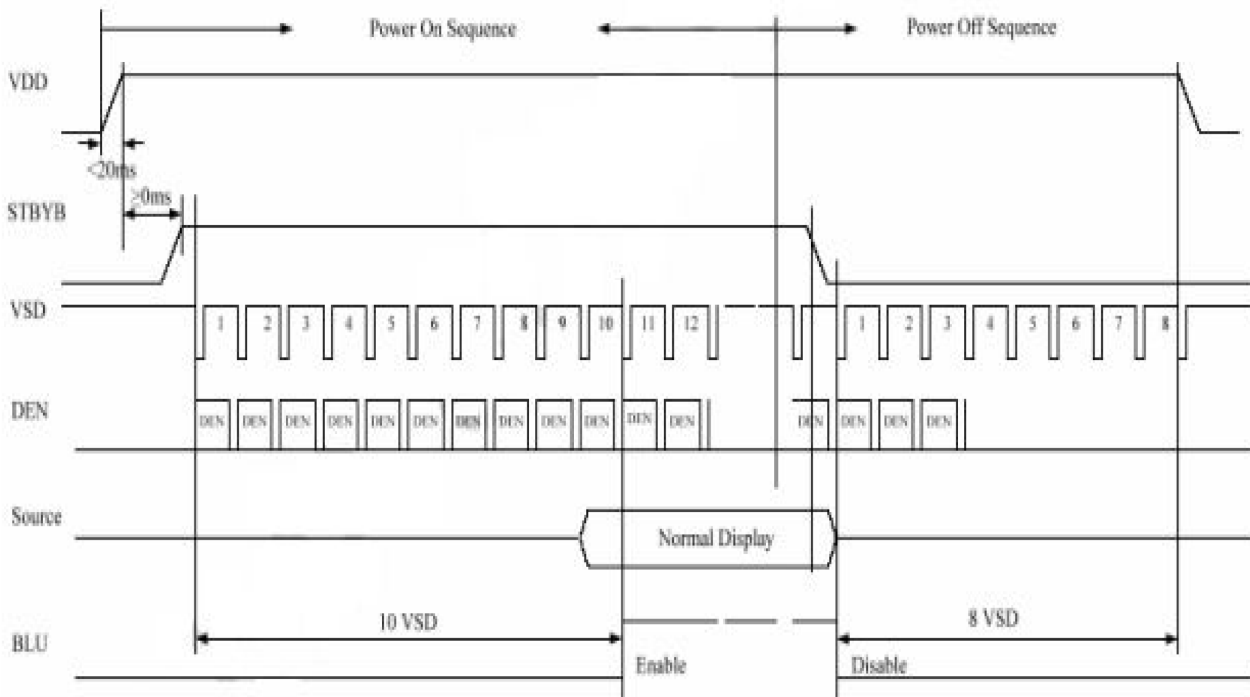

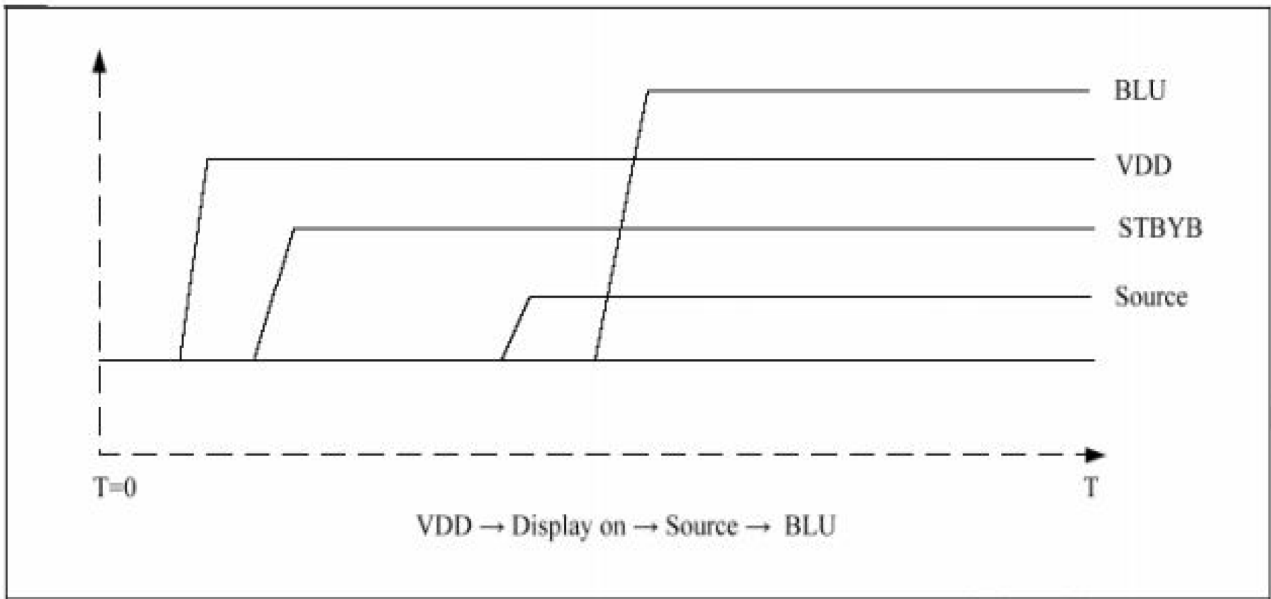

Power On Sequence

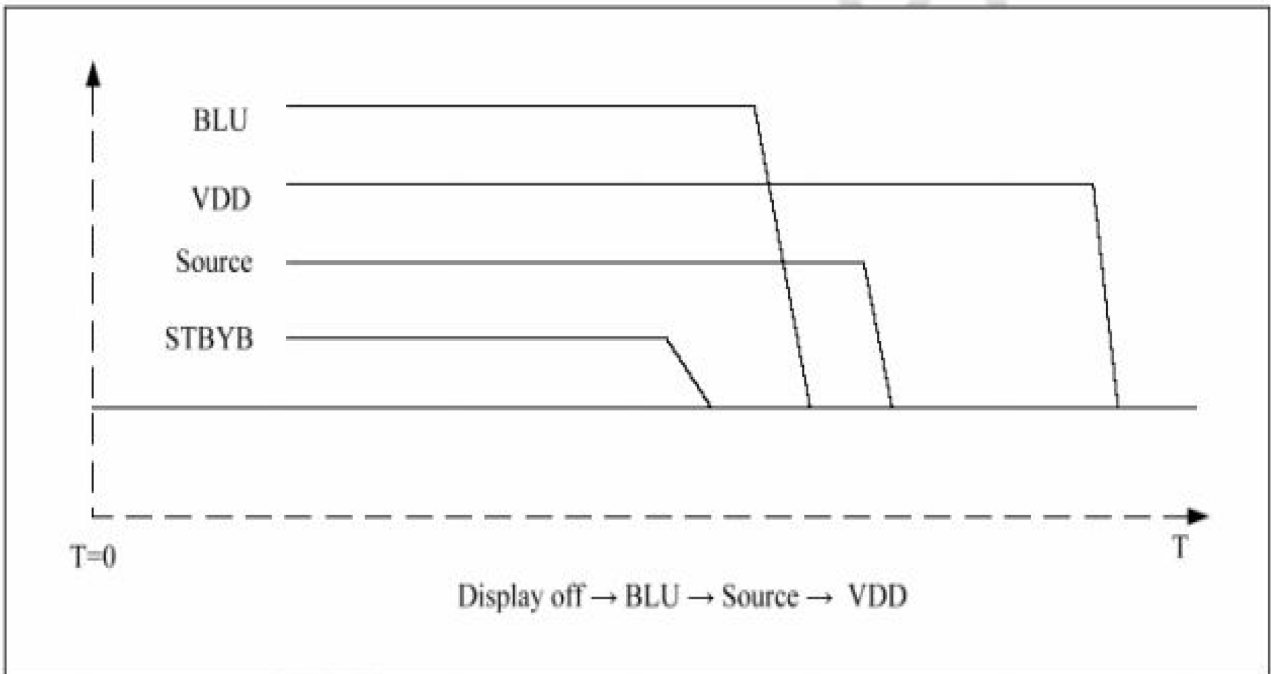

Power Off Sequence

### 9. Optical Specification

Ta=25°C

Item	Symbol	Condition	Min	Typ	Max	Unit	Remark
Contrast Ratio	CR	$\theta=0^\circ$	400	500	-		Note 1 Note 2
Response Time	Ton/Toff	25°C	-	20	30	ms	Note 1 Note 3
View Angles	$\theta T$	$CR \geq 10$	40	50	-	Degree	Note 4
	$\theta B$		60	70	-		
	$\theta L$		60	70	-		
	$\theta R$		60	70	-		
Chromaticity	Red	Brightness is on	X	0.618	-		Note 1 Note 5
			Y	0.326	-		
	Green		X	0.317	-		
			Y	0.568	-		
	Blue		X	0.127	-		
			Y	0.165	-		
White	X	0.330	-				
	Y	0.357	-				
NTSC	S		-	50	-	%	Note 5
Luminance	L		-	240	-	cd/m <sup>2</sup>	Note 1 Note 6
Uniformity	U		75	80	-	%	Note 1 Note 7

Note 1: Definition of optical measurement system.

Temperature = 25°C(±3°C)

LED back-light: ON, Environment brightness < 150 lx

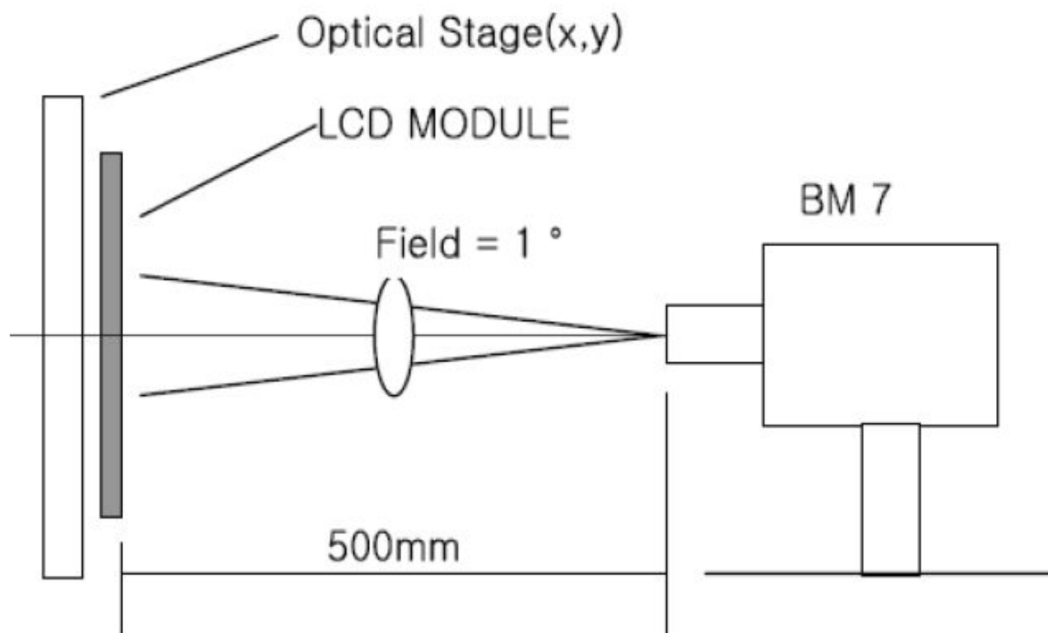

Note 2: Contrast ratio is defined as follow:

$$\text{Contrast Ratio} = \frac{\text{Surface Luminance with all white pixels}}{\text{Surface Luminance with all black pixels}}$$

Note 3: Response time is defined as follow:

Response time is the time required for the display to transition from black to white (Rise Time,  $T_r$ ) and from white to black(Decay Time,  $T_f$ ).

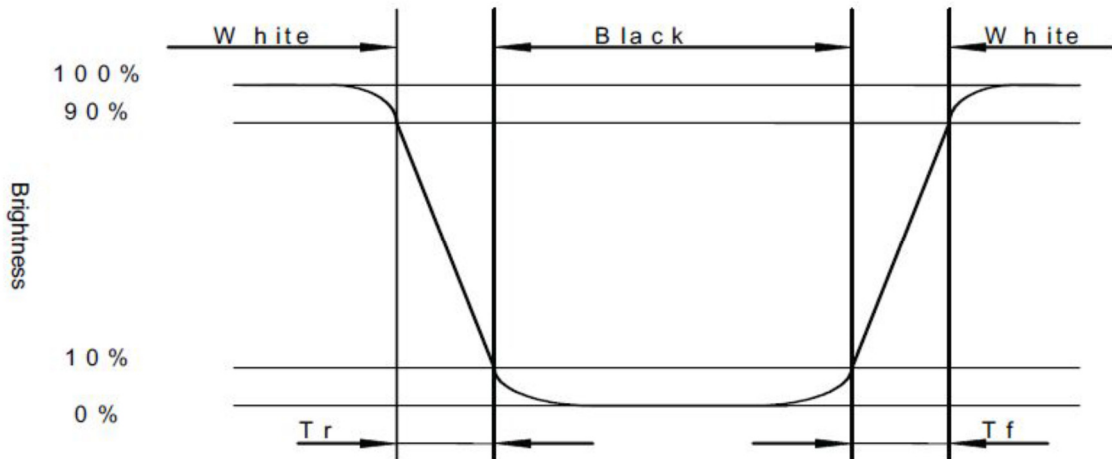

Note 4: Viewing angle range is defined as follow:

Viewing angle is measured at the center point of the LCD.

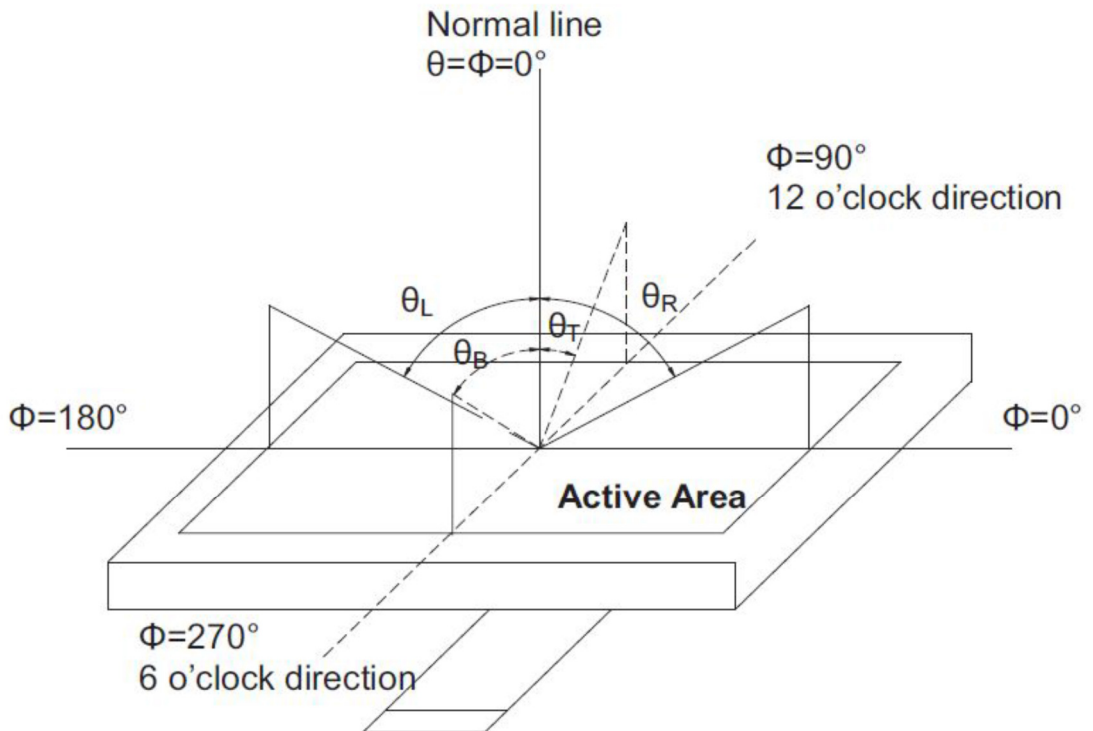

Note 5: Color chromaticity is defined as follow: (CIE1931)

Color coordinates measured at center point of LCD.

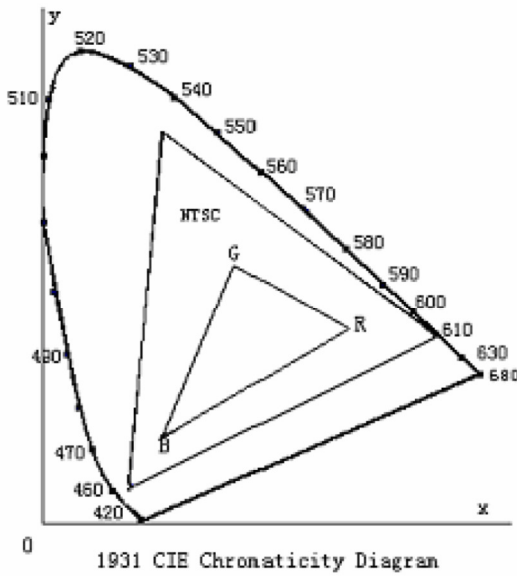

$$S = \frac{\text{area of RGB triangle}}{\text{area of NTSC triangle}} \times 100\%$$

Note 6: Luminance is defined as follow:

Luminance is defined as the brightness of all pixels “White” at the center of display area on optimum contrast.

Note 7: Luminance Uniformity is defined as follow:

Active area is divided into 9 measuring areas (Refer Fig. 2). Every measuring point is placed at the center of each measuring area.

$$\text{Uniformity (U)} = \frac{\text{Minimum Luminance( brightness ) in 9 points}}{\text{Maximum Luminance( brightness ) in 9 points}}$$

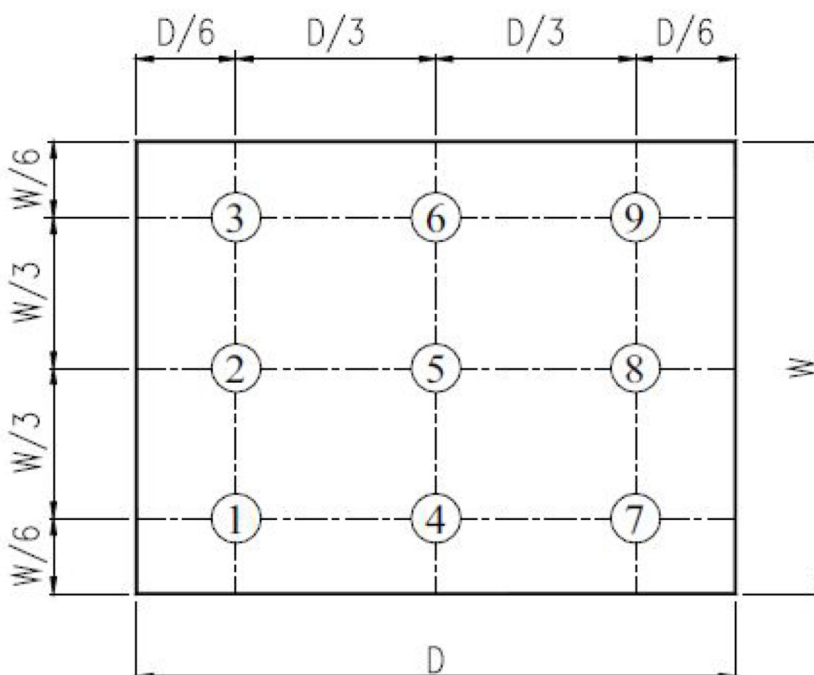

Fig. 2 Definition of uniformity

## 10. Environmental / Reliability Tests

No	Test Item	Condition	Judgment Criteria
1	High Temp Operation	Ts=+70°C, 120hrs	Per table in below
2	Low Temp Operation	Ta=-20°C, 120hrs	Per table in below
3	High Temp Storage	Ta=+80°C, 120hrs	Per table in below
4	Low Temp Storage	Ta=-30°C, 120hrs	Per table in below
5	High Temp & High Humidity Storage	Ta=+60°C, 90% RH 120 hours	Per table in below (polarizer discoloration is excluded)
6	Thermal Shock (Non-operation)	-30°C 30 min~+80°C 30 min, Change time: 5min, 10 Cycles	Per table in below
7	ESD (Operation)	C=150pF, R=330Ω, 5points/panel Air: ±8KV, 5times; Contact: ±4KV, 5 times;	Per table in below
8	Vibration (Non-operation)	Frequency range: 10~55Hz, Stroke: 1.5mm Sweep: 10Hz~55Hz~10Hz 2 hours for each direction of X.Y.Z.	Per table in below
9	Shock (Non-operation)	60G 6ms, ±X,±Y,±Z 3times, for each direction	Per table in below
10	Package Drop Test	Height: 80 cm, 1 corner, 3 edges, 6 surfaces	Per table in below

Inspection	Criterion (after test)
Appearance	No Crack on the FPC, on the LCD Panel
Alignment of LCD Panel	No Bubbles in the LCD Panel No other Defects of Alignment in Active area
Electrical current	Within device specifications
Function / Display	No Broken Circuit, No Short Circuit or No Black line No Other Defects of Display

## 11. Precautions for Use of LCD Modules

### 11.1 Safety

The liquid crystal in the LCD is poisonous. Do not put it in your mouth. If the liquid crystal touches your skin or clothes, wash it off immediately using soap and water.

### 11.2 Handling

- A. The LCD and touch panel is made of plate glass. Do not subject the panel to mechanical shock or to excessive force on its surface.
- B. Do not handle the product by holding the flexible pattern portion in order to assure the Reliability
- C. Transparency is an important factor for the touch panel. Please wear clear finger sacks, gloves and mask to protect the touch panel from finger print or stain and also hold the portion outside the view area when handling the touch panel.
- D. Provide a space so that the panel does not come into contact with other components.

- E. To protect the product from external force, put a covering lens (acrylic board or similar board) and keep an appropriate gap between them.
- F. Transparent electrodes may be disconnected if the panel is used under environmental conditions where dew condensation occurs.
- G. Property of semiconductor devices may be affected when they are exposed to light, possibly resulting in IC malfunctions.
- H. To prevent such IC malfunctions, your design and mounting layout shall be done in the way that the IC is not exposed to light in actual use.

### 11.3 Static Electricity

- A. Ground soldering iron tips, tools and testers when they are in operation.
- B. Ground your body when handling the products.
- C. Power on the LCD module before applying the voltage to the input terminals.
- D. Do not apply voltage which exceeds the absolute maximum rating.
- E. Store the products in an anti-electrostatic bag or container.

### 11.4 Storage

- A. Store the products in a dark place at  $+25^{\circ}\text{C}\pm 10^{\circ}\text{C}$  with low humidity (40% RH to 60% RH). Don't expose to sunlight or fluorescent light.
- B. Storage in a clean environment, free from dust, active gas, and solvent.

### 11.5 Cleaning

- A. Do not wipe the touch panel with dry cloth, as it may cause scratch.
- B. Wipe off the stain on the product by using soft cloth moistened with ethanol. Do not allow ethanol to get in between the upper film and the bottom glass. It may cause peeling issue or defective operation. Do not use any organic solvent or detergent other than ethanol.

### 11.6 Cautions for installing and assembling

Bezel edge must be positioned in the area between the Active area and View area. The bezel may press the touch screen and cause activation if the edge touches the active area. A gap of approximately 0.5mm is needed between the bezel and the top electrode. It may cause unexpected activation if the gap is too narrow. There is a tolerance of 0.2 to 0.3mm for the outside dimensions of the touch panel and tail. A gap must be made to absorb the tolerance in the case and connector.

