

TOP VIEW

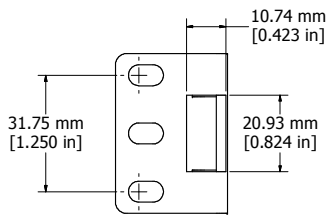

(1) REAR SUPPORT BRACKET
FRONT VIEW

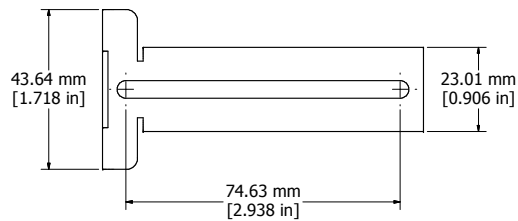

SIDE VIEW

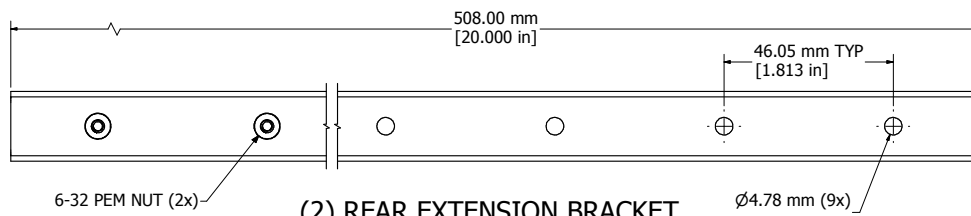

(2) REAR EXTENSION BRACKET
SIDE VIEW

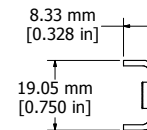



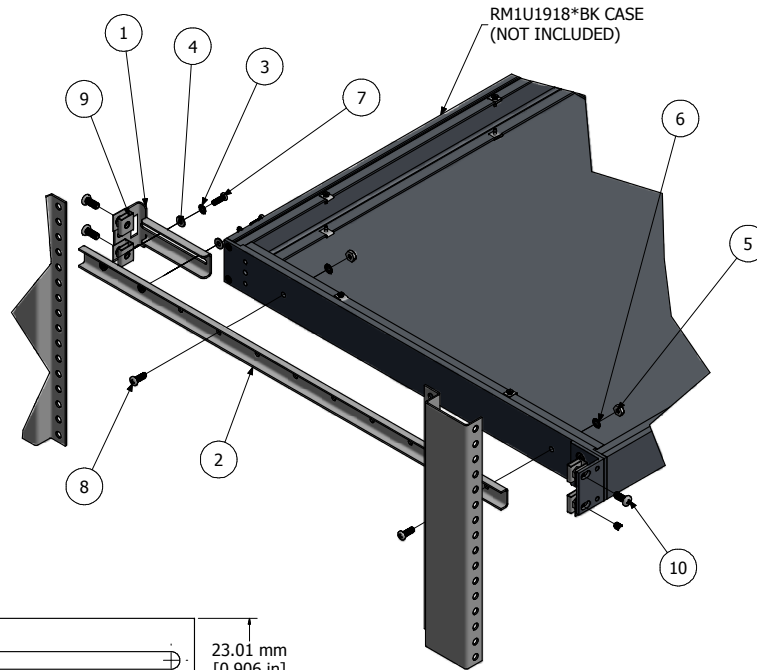



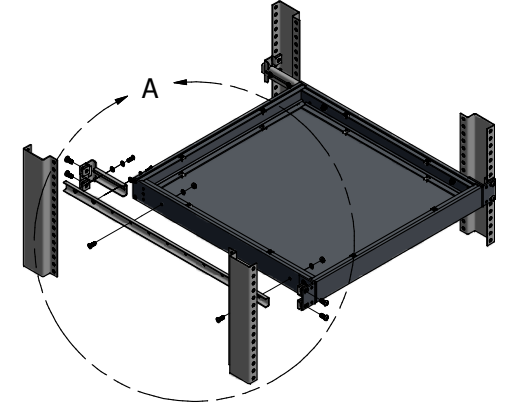

FRONT VIEW



DETAIL A



ISOMETRIC VIEW (EXPLODED)

 (3) #6 EXT. TOOTH WSH.	 (4) #6 FLAT WASHER
 (5) #8 HEX NUT	 (6) #8 INT. TOOTH WSH.
 (7) 6-32 x 1/2" SCREW	 (8) 8-32 x 1/2" SCREW
 (9) 10-32 CLIP NUT (NOT SUPPLIED)	 (10) 10-32 x 1/2" SCREW (NOT SUPPLIED)

RM1U18BRKT
2 x Extension Bracket - 16 GA. Steel (Black)
2 x Rear Support Bracket - 16 GA Steel (Black)
Hardware as shown above*

