

## 2-Way 0° Power Divider 5 to 1000 MHz

Rev. V3

### Features

- Surface Mount, hermetically sealed
- 2 Way, 0 Degree
- 260°C Reflow Compatible
- RoHS\* Compliant
- RoHS version of ESSMJ-2-12-75TR
- 75 Ohm
- Available on Tape and Reel

### Description

M/A-COM's MAPD-008108-C202C0 is a 2 Way 0° Power Divider in a low cost, surface mount package. Ideally suited for high volume CATV/Broadband applications.

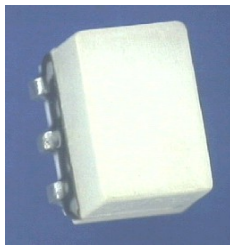

### Schematic

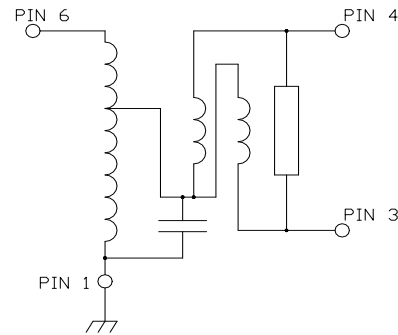

### Case style: SM-44

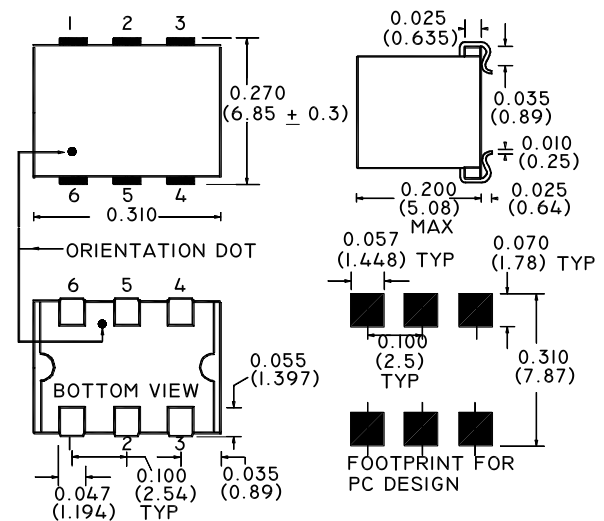

Dimensions in inches [mm] Tolerance: .xx ± .02, .xxx ± .010

### Pin configuration

Pin No.	Function
1	Ground
2	Not Connected
3	Output Port 2
4	Output Port 1
5	Not Connected
6	Input

Note: Reference Application Note **M513** for reel size information.

\* Restrictions on Hazardous Substances, European Union Directive 2002/95/EC.

### Ordering information

Part Number	Description
MAPD-008108-C202C0	900 per reel
MAPD-008108-C202TB	Customer Test Board

### Electrical Specifications: $T_A = 25^\circ\text{C}$ , $Z_0 = 75\Omega$ , $P_{IN} = 0\text{dBm}$

Parameter	Frequency	Units	Minimum	Typical	Maximum
Insertion Loss	5 - 500 MHz	dB	—	0.4	0.6
	500 - 1000 MHz	dB	—	0.5	1.2
Isolation	5 - 600 MHz	dB	20	35	—
	600 - 1000 MHz	dB	17.5	30	—
Amplitude Unbalance	5 - 600 MHz	dB	—	—	0.2
	600 - 1000 MHz	dB	—	—	0.5
Phase Unbalance	5 - 100 MHz	°	—	—	1.5
	100 - 500 MHz	°	—	—	3.5
	500 - 1000 MHz	°	—	—	4.0
Output Return Loss	5 - 40 MHz	dB	12	20	—
	40 - 1000 MHz	dB	20	25	—
Input Return Loss	5 - 40 MHz	dB	13.5	20	—
	40 - 500 MHz	dB	20	24	—
	500 - 860 MHz	dB	17	21	—
	860 - 1000 MHz	dB	14	19	—
Insertion Loss Flatness	5 - 1000 MHz	dB	—	—	0.9

### Absolute maximum ratings <sup>1,2</sup>

Parameter	Absolute Maximum
RF Power	1 Watt
Internal Load Dissipation	0.125 Watt
Pin Temp (10 sec.)	260°C
Storage Temperature	-55°C to +100°C
Operating Temperature	-40°C to +85°C

1. Exceeding any one or combination of these limits may cause permanent damage to this device.
2. M/A-COM does not recommend sustained operation near these survivability limits.

## 2-Way 0° Power Divider 5 to 1000 MHz

Rev. V3

Typical Performance Curves:  $T_A = 25^\circ\text{C}$ ,  $Z_0 = 75\Omega$ ,  $P_{IN} = 0\text{dBm}$

Insertion Loss

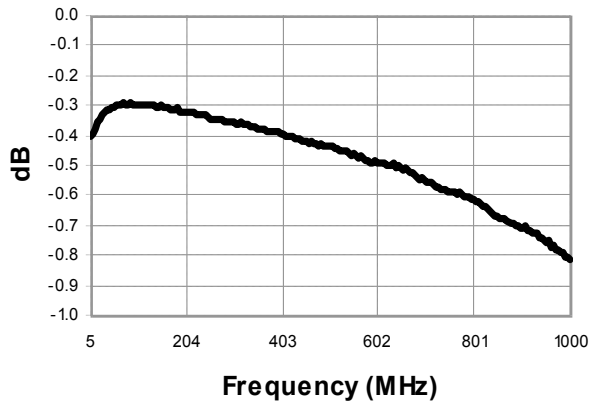

Isolation

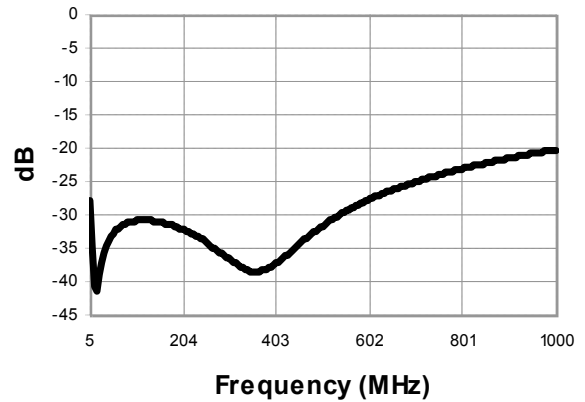

Amplitude Balance

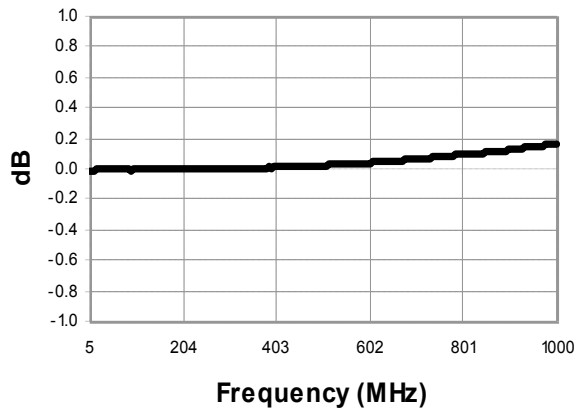

Phase Balance

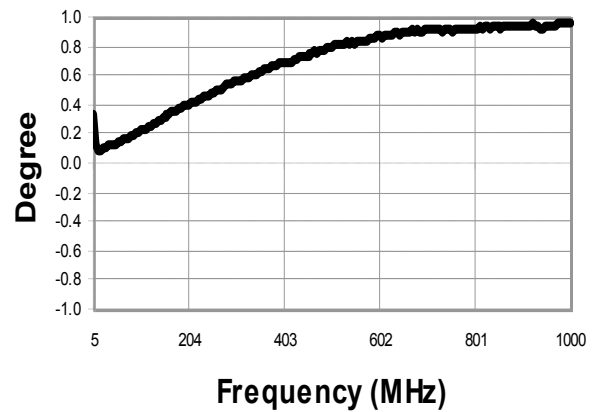

Return Loss: Input

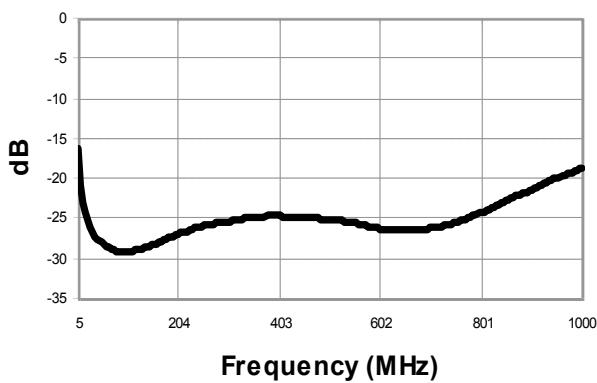

Return Loss: Output

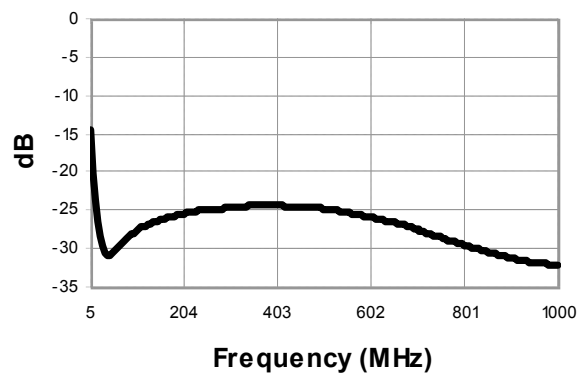

M/A-COM Technology Solutions Inc. All rights reserved.

Information in this document is provided in connection with M/A-COM Technology Solutions Inc ("MACOM") products. These materials are provided by MACOM as a service to its customers and may be used for informational purposes only. Except as provided in MACOM's Terms and Conditions of Sale for such products or in any separate agreement related to this document, MACOM assumes no liability whatsoever. MACOM assumes no responsibility for errors or omissions in these materials. MACOM may make changes to specifications and product descriptions at any time, without notice. MACOM makes no commitment to update the information and shall have no responsibility whatsoever for conflicts or incompatibilities arising from future changes to its specifications and product descriptions. No license, express or implied, by estoppel or otherwise, to any intellectual property rights is granted by this document.

THESE MATERIALS ARE PROVIDED "AS IS" WITHOUT WARRANTY OF ANY KIND, EITHER EXPRESS OR IMPLIED, RELATING TO SALE AND/OR USE OF MACOM PRODUCTS INCLUDING LIABILITY OR WARRANTIES RELATING TO FITNESS FOR A PARTICULAR PURPOSE, CONSEQUENTIAL OR INCIDENTAL DAMAGES, MERCHANTABILITY, OR INFRINGEMENT OF ANY PATENT, COPYRIGHT OR OTHER INTELLECTUAL PROPERTY RIGHT. MACOM FURTHER DOES NOT WARRANT THE ACCURACY OR COMPLETENESS OF THE INFORMATION, TEXT, GRAPHICS OR OTHER ITEMS CONTAINED WITHIN THESE MATERIALS. MACOM SHALL NOT BE LIABLE FOR ANY SPECIAL, INDIRECT, INCIDENTAL, OR CONSEQUENTIAL DAMAGES, INCLUDING WITHOUT LIMITATION, LOST REVENUES OR LOST PROFITS, WHICH MAY RESULT FROM THE USE OF THESE MATERIALS.

MACOM products are not intended for use in medical, lifesaving or life sustaining applications. MACOM customers using or selling MACOM products for use in such applications do so at their own risk and agree to fully indemnify MACOM for any damages resulting from such improper use or sale.