

PADS OF PRODUCT FOR SOLDER

LOGO WITH SERIES NO.

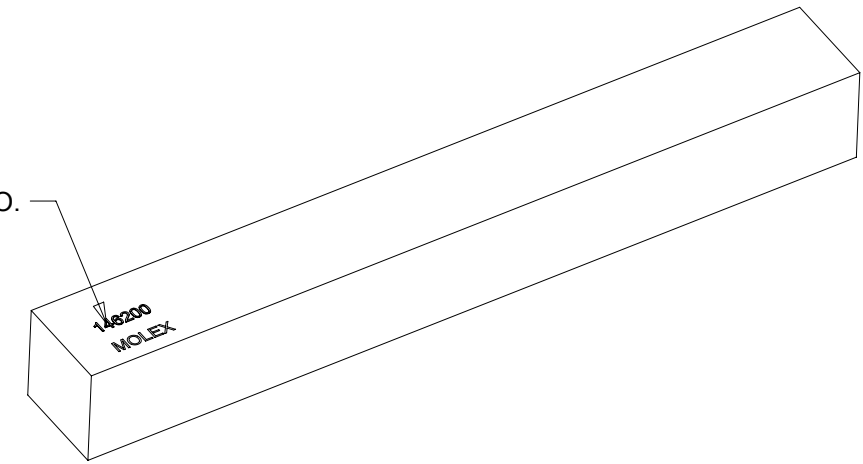

3D VIEW

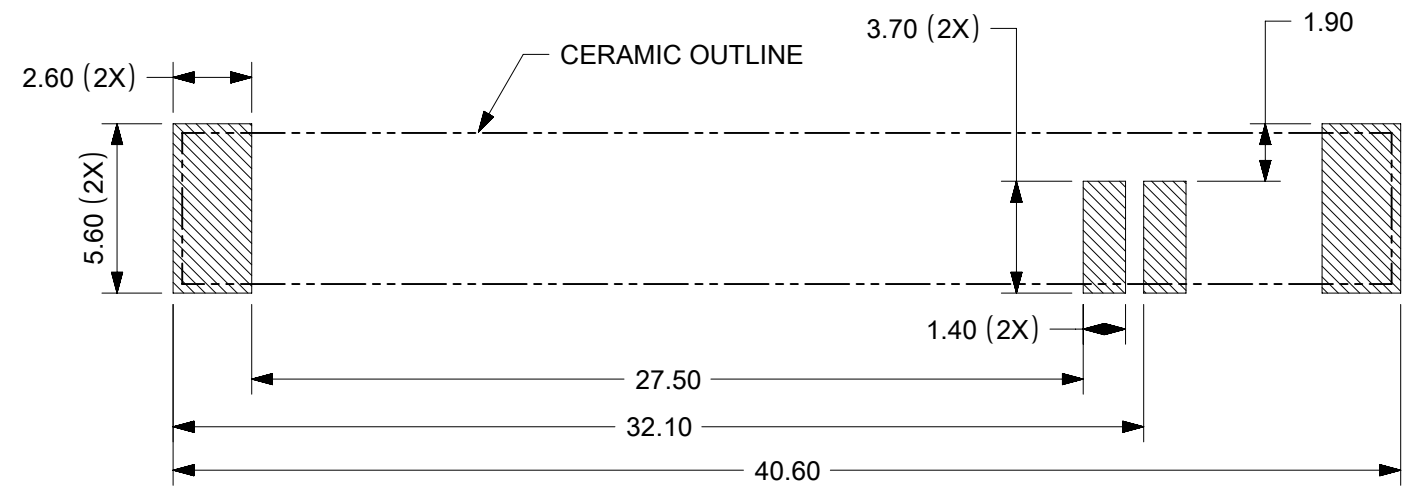

RECOMMENDED PCB LAYOUT

NOTES:

1. MATERIAL: CERAMIC, P/N: 1462000001
2. PATTERN: Ag PLATED, THICKNESS 6-11um
3. PACKAGE SPEC. REFER TO PK OF 1462000001
4. PRODUCT SPEC. REFER TO PS OF 1462000001
5. APPLICATION SPEC. REFER TO AS OF 1462000001
6. SUGGEST TO USE RED GLUE UNDER PART BEFORE SMT IF APPLICATION CONDITION IS STRICT

THIS DRAWING CONTAINS INFORMATION THAT IS PROPRIETARY TO MOLEX ELECTRONIC TECHNOLOGIES, LLC AND SHOULD NOT BE USED WITHOUT WRITTEN PERMISSION										
QUALITY SYMBOLS ▽ = 0 ▽ = 0 ▽ = 0 ▼ = 0 ▽ = 0 ⊠ = 0 ■ = 0 ▽ = 0	EC NO: 170025 DRWN: KCHENG06 CHKD: CXU11 APPR: XJISONG	GENERAL TOLERANCES (UNLESS SPECIFIED)		DIMENSION UNITS	SCALE					
		ANGULAR TOL ± 0.5 °		MM	4:1					
		4 PLACES ±	DRWN BY		DATE		698MHZ-2.7GHZ FULL LTE SMT ANTENNA			
		3 PLACES ± 0.2	TZHOU07		2016/03/25					
2 PLACES ± 0.3	CHK'D BY		DATE		PRODUCT CUSTOMER DRAWING					
1 PLACE ± 0.5	YXGAO04		2016/05/24							
0 PLACES ± 1.0	APPR BY		DATE		SERIES: 146200 MATERIAL NUMBER: 1462000001 CUSTOMER: GENERAL MARKET					
DRAFT WHERE APPLICABLE MUST REMAIN WITHIN DIMENSIONS		CYU08		2016/07/14						
		DRAWING SIZE	THIRD ANGLE PROJECTION			DOCUMENT NUMBER: 1462000001 DOC TYPE: PSD DOC PART: 000 SHEET NUMBER: 1 OF 2				
		A3								

RELEASE STATUS	P1	RELEASE DATE	29.12.2017	04:01:46
----------------	----	--------------	------------	----------

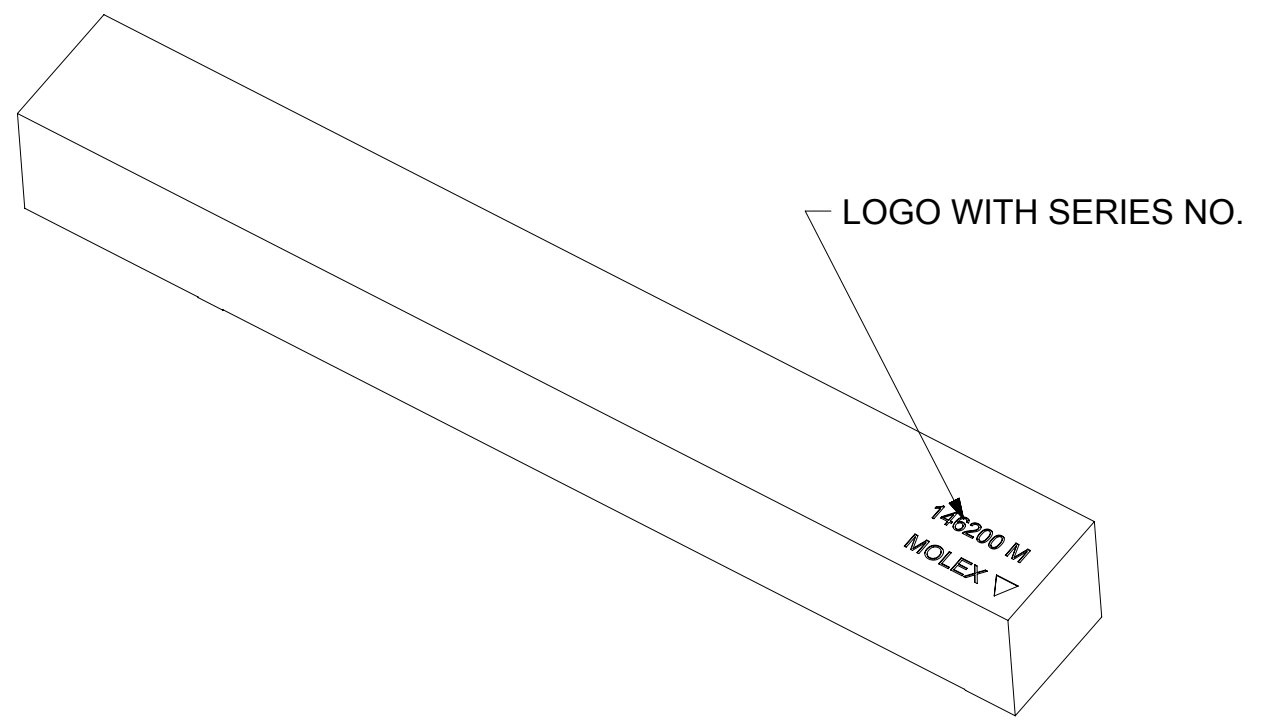
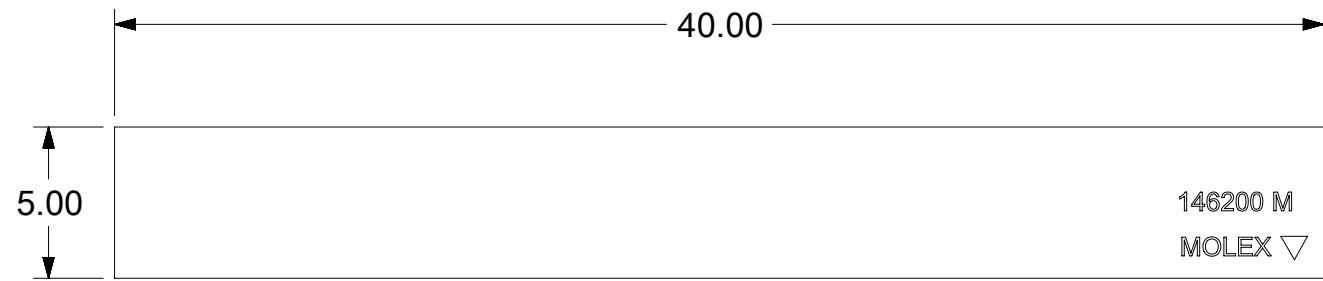

3D VIEW

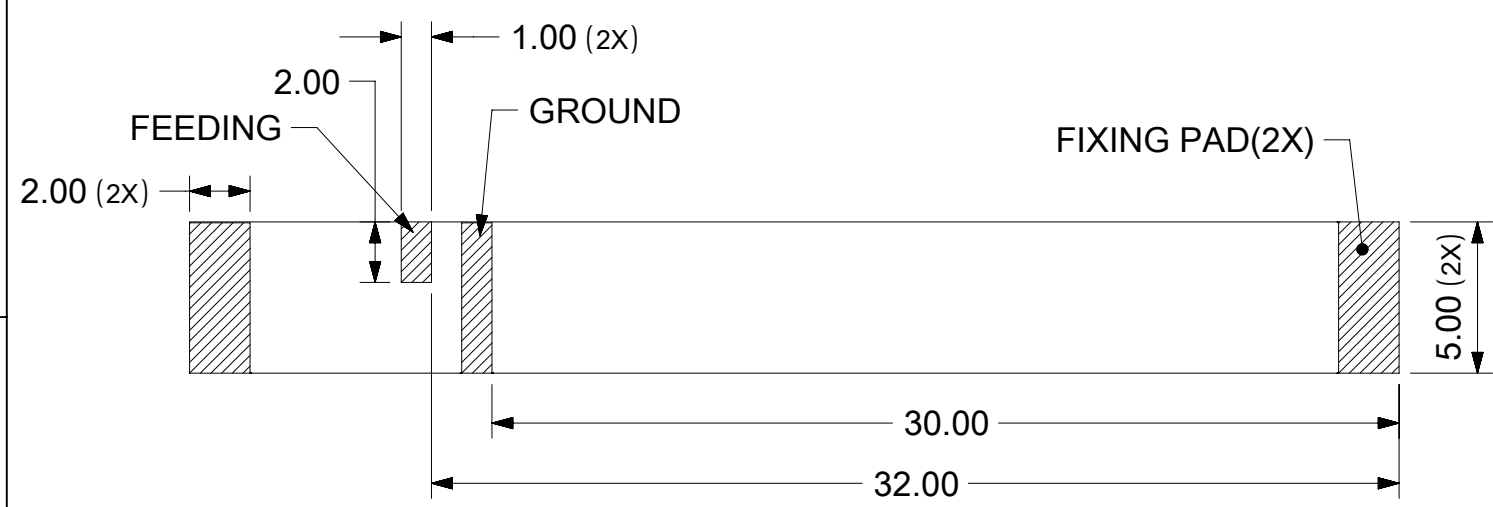
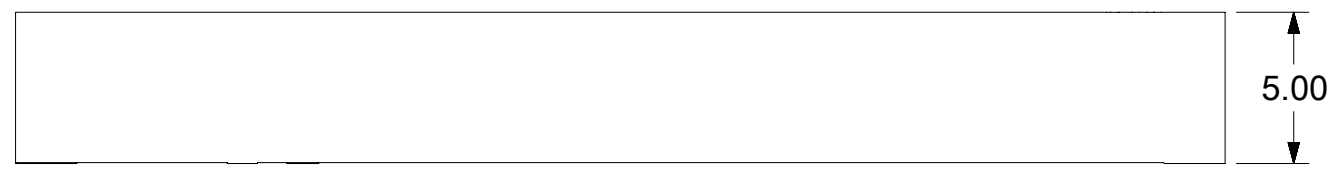

PADS OF PRODUCT FOR SOLDER

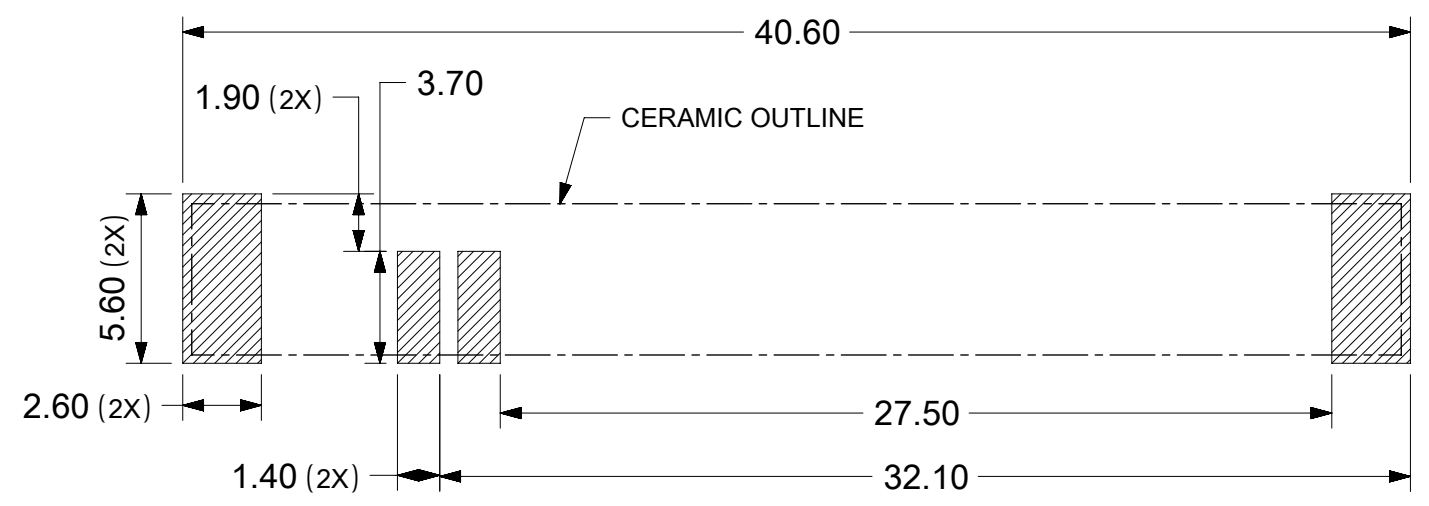

RECOMMENDED PCB LAYOUT

- NOTES:
1. MATERIAL: CERAMIC, P/N: 1462000011
 2. PATTERN: Ag PLATED, THICKNESS 6-11um
 3. PACKAGE SPEC. REFER TO PK OF 1462000001
 4. PRODUCT SPEC. REFER TO PS OF 1462000001
 5. APPLICATION SPEC. REFER TO AS OF 1462000001
 6. SUGGEST TO USE RED GLUE UNDER PART BEFORE SMT IF APPLICATION CONDITION IS STRICT

THIS DRAWING CONTAINS INFORMATION THAT IS PROPRIETARY TO MOLEX ELECTRONIC TECHNOLOGIES, LLC AND SHOULD NOT BE USED WITHOUT WRITTEN PERMISSION												
QUALITY SYMBOLS	EC NO: 170025 DRWN: KCHENG06 CHK'D: CXU11 APPR: XJISONG	GENERAL TOLERANCES (UNLESS SPECIFIED)		DIMENSION UNITS	SCALE							
		ANGULAR TOL ± 0.5 °		MM	4:1							
▽A = 0	C2 REV	4 PLACES ±	DRWN BY	TZHOU07		DATE		698MHZ-2.7GHZ FULL LTE SMT ANTENNA				
▽E = 0		3 PLACES ± 0.2	CHK'D BY	YXGAO04		DATE		PRODUCT CUSTOMER DRAWING				
▽F = 0		2 PLACES ± 0.3	APPR BY	CYU08		DATE		SERIES	MATERIAL NUMBER	CUSTOMER		
▽ = 0		1 PLACE ± 0.5	DRAWING SIZE		THIRD ANGLE PROJECTION		146200	GENERAL MARKET				
▽ = 0		0 PLACES ± 1.0	A3				DOCUMENT NUMBER		DOC TYPE	DOC PART	SHEET NUMBER	
▽ = 0		DRAFT WHERE APPLICABLE MUST REMAIN WITHIN DIMENSIONS						1462000001	PSD	000	2 OF 2	