

LTM4615EV: Dual DC/DC Step-Down µModule Regulator with LDO

DESCRIPTION

Demonstration circuit 1367A features the LTM[®]4615EV, a triple output µModule[®] regulator consisting of two switch mode outputs and one LDO output. Each LTM4615 DC/DC converter has a separate input and enable pin. The LTM4615 maximum load current is 4A for each switch mode channel and 1.5A for the VLDO[™] channel. However the DC1367A is configured with the LDO input supply connected to the VOUT2 whose maximum output current decreases accordingly. Derating is necessary for certain V_{IN} , V_{OUT}

and thermal conditions. The LTM4615 data sheet must be read in conjunction with this manual prior to working on or modifying DC1367A.

Design files for this circuit board are available at <http://www.linear.com/demo>

LT, LT, LTC, LTM, µModule, Linear Technology and the Linear logo are registered trademarks and VLDO is a trademark of Linear Technology Corporation. All other trademarks are the property of their respective owners.

PERFORMANCE SUMMARY (T_A = 25°C)

PARAMETER	CONDITION	VALUE
Input Voltage Range	Both Switch Mode Outputs (V_{IN1} and V_{IN2})	2.5V to 5.5V
Output Voltage V_{OUT1}	DC Voltage, $V_{IN1} = 3.3V$, $I_{OUT1} = 4A$	1.8V ±2%
Output Voltage V_{OUT2}	DC Voltage, $V_{IN2} = 3.3V$, $I_{OUT2} = 2.5A$	1.2V ±2%
Output Voltage $V_{O3(LDO)}$	DC Voltage, $V_{IN2} = 3.3V$, $I_{OUT3} = 1.5A$	1.0V ±2%
Maximum Continuous Output Current	Note: $I_{OUT2} = 4.0A - I_{O3}$	4A DC at V_{OUT1} , 4A DC at V_{OUT2} , 1.5A DC at V_{O3}
Default Operating Frequency	For 2 Switching Mode Channels	1.25MHz
Efficiency of Channel 1	$V_{IN1} = 5.5V$, $V_{OUT1} = 1.8V$, $I_{OUT1} = 4A$	82.8%, See Figure 3
Efficiency of Channel 2	$V_{IN2} = 5.5V$, $V_{OUT2} = 1.2V$, $I_{OUT2} = 2.5A$	81.7%, See Figure 3

BOARD PHOTO

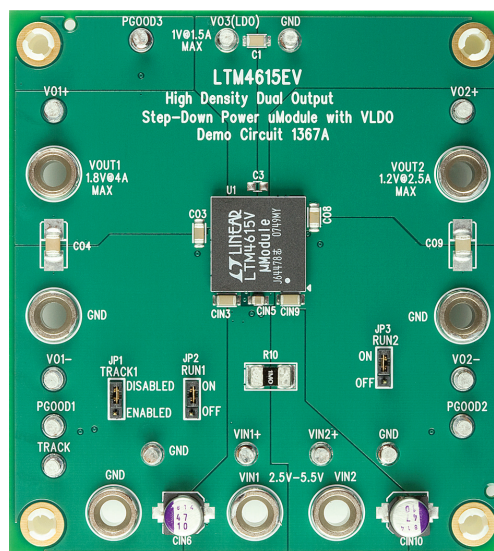

dc1367af

DEMO MANUAL DC1367A

QUICK START PROCEDURE

Demonstration circuit 1367A is an easy way to evaluate the performance of the LTM4615. Please refer to Figure 1 for proper measurement equipment setup and follow the procedure below:

1. Place jumpers in the following positions for a typical 1.8V, 1.2V and 1.0V application:

TRACK1	RUN1	RUN2
DISABLED	ON	ON

2. With power off, preset the loads to 0A and V_{IN} supply to be 5V. Connect the input power supply, load and meters as shown in Figure 1.
3. Turn on the power at the input. The output voltage between $VO1+$ and $VO1-$ should be $1.8V \pm 2\%$, the voltage between $VO2+$ and $VO2-$ should be $1.2V \pm 2\%$, and the voltage between $VO3(LDO)$ and GND should be $1.0V \pm 2\%$.

4. Once the proper output voltage is established, adjust the load within the operating range and observe the output voltage regulation, ripple voltage, efficiency and other parameters. To measure input and output ripple, please refer to Figure 2 for proper setup.
5. $VOUT1$ can track another supply by connecting TP14, TRACK to the supply rail and setting JP1 to ENABLED. When R8 equals RSET1, $VOUT1$ is set up for coincidental tracking. $VOUT2$ is set up to coincidentally track $VOUT1$ as determined by resistors R6 and R7. Please refer to the circuit schematic and data sheet.
6. $VOUT2$ is used as the input supply for the 1.5A LDO. Therefore, if the jumper of JP3 (RUN2) is placed at OFF position, both channel 2 and 3 will be turned off.
7. Because DC1367A is designed so $VOUT2$ tracks $VOUT1$ automatically, placing the JP2 (RUN1) to OFF position turns off all three outputs. To disable tracking on $VOUT2$, please remove R6 and R7 and connect TRACK2 to $VIN2$.
8. $VIN1$ and $VIN2$ are shorted on DC1367A through a $1m\Omega$ resistor, R10. If desired, remove R10 to allow separate V_{IN1} and V_{IN2} power supplies.

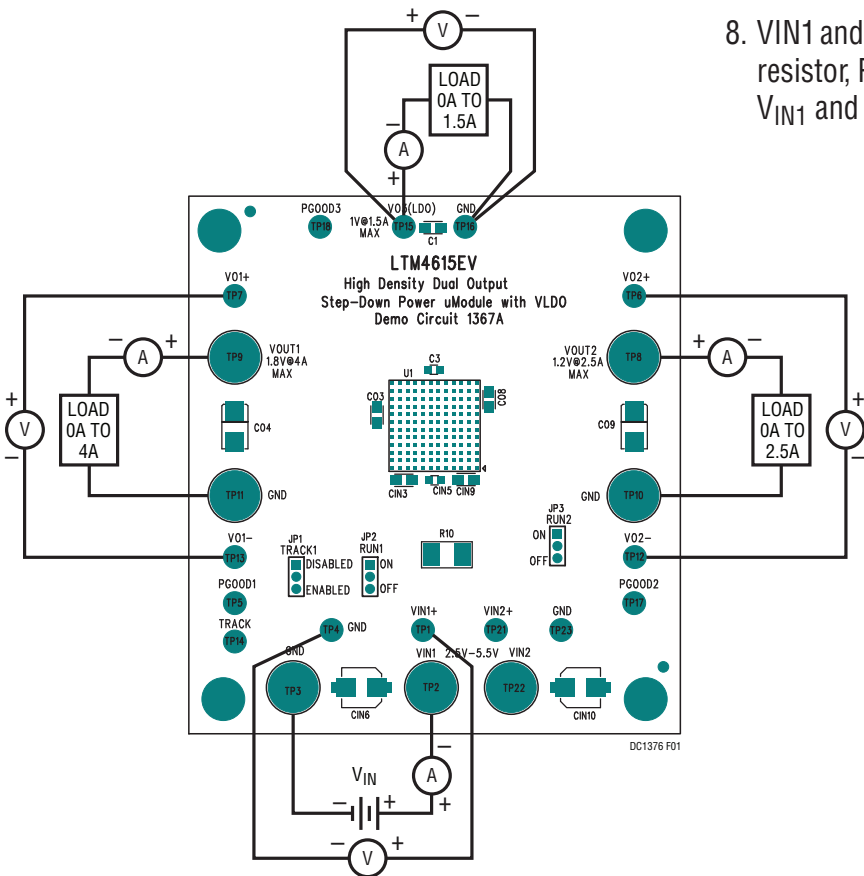

Figure 1. Test Setup of DC1367A

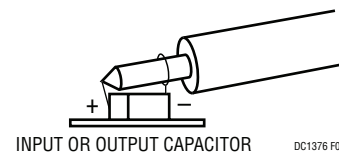

Figure 2. Proper Scope Probe Placement for Measuring Input or Output Ripple

QUICK START PROCEDURE

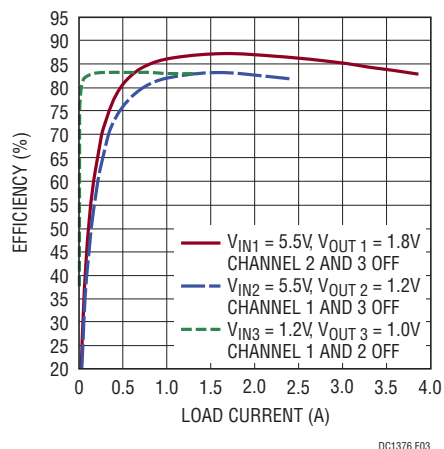

Figure 3. Measured Efficiency for Different Channels

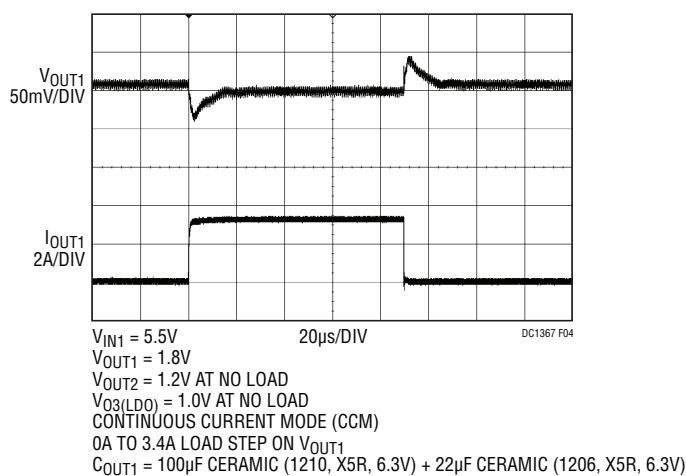

Figure 4. Measured Load Transient Response for V_{OUT1}

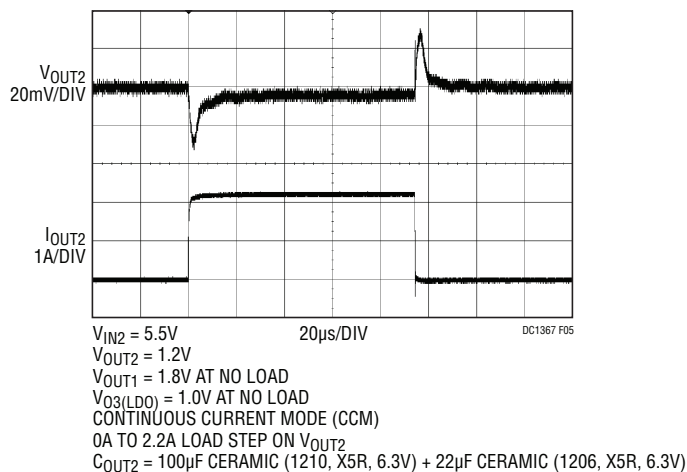

Figure 5. Measured Load Transient Response for V_{OUT2}

DEMO MANUAL DC1367A

PARTS LIST

ITEM	QTY	REFERENCE	PART DESCRIPTION	MANUFACTURER/PART NUMBER
Required Circuit Components				
1	2	CIN6, CIN10	CAP, OS-CON, 47µF 10V, C6 SIZE	SANYO, 10SVP47M
2	2	CO4, CO9	CAP, X5R, 100µF, 6.3V, 10%, 1210-7343	AVX, 12106D107KAT2A
3	2	CO3, CO8	CAP, X5R, 22µF, 6.3V, 20%, 1206-0805	AVX, 12066D226MAT2A
4	5	C1, CIN3, CIN4, CIN8, CIN9	CAP, X5R, 10µF, 6.3V, 20%, 1206-0805	AVX, 12066D106MAT2A
5	1	CIN5	CAP, X5R, 10µF, 6.3V, 20%, 0805-0603	AVX, 08056D106MAT2A
6	1	L1	IND, 0.2µH	Fair-Rite, 2508056017Y2
7	1	RSET1	RES., CHIP, 4.02k, 1/16W, 1%, 0603	VISHAY, CRCW06034K02FKEA
8	2	RSET2, R7	RES., CHIP, 10k, 1/16W, 1%, 0603	VISHAY, CRCW060310K0FKEA
9	1	RSET3	RES., CHIP, 3.32k, 1/16W, 1%, 0603	VISHAY, CRCW060333K2FKEA
10	3	R1,R2, R9	RES., CHIP, 100k, 1/16W, 1%, 0603	VISHAY, CRCW0603100KFKEA
11	1	R6	RES., CHIP, 4.99k, 1/16W, 1%, 0603	VISHAY, CRCW06034K99FKEA
12	1	U1	I.C., LTM4615EV#PBF, LGA	LINEAR TECH., LTM4615EV#PBF
Additional Demo Board Circuit Components				
1	0	CO1, CO6 (OPT)	CAP, 1206-0805	
2	0	CSS1, CSS2, CP1, CP2, C3, C4 (OPT)	CAP, 0603	
3	0	COMP1, COMP2, CFF1, CFF2 (OPT)	CAP, 0603	
4	0	CO5, CO7, CO10, CO2(OPT)	CAP, 1210-7343	
5	0	R8	RES., CHIP, 0603	
6	1	R5	RES., CHIP, 4.99k, 1/16W, 1%, 0603	VISHAY, CRCW06034K99FKEA
7	1	R10	RES., CHIP, 1M, 1W, 1%, 2512	PANASONIC, ERJM1WTJ1M0U
Hardware For Demo Board Only				
1	3	JP1, JP2, JP3	2MM SINGLE ROW HEADER, 3 PIN	SAMTEC, TMM-103-02-L-S
2	3	JP1, JP2, JP3	SHUNT,	SAMTEC, 2SN-BK-G
3	7	TP8-TP11, TP22, TP2, TP3	BANANA JACK,	KEYSTONE, 575-4
4	14	TP1, TP4-TP7, TP12-TP18, TP21, TP23	TESTPOINT, TURRET, .095"	MILL-MAX, 2501-2-00-80-00-00-07-0
5	4	STAND OFF	STAND-OFF, NYLON 0.50" tall	KEYSTONE, 8833 (SNAP ON)

SCHEMATIC DIAGRAM

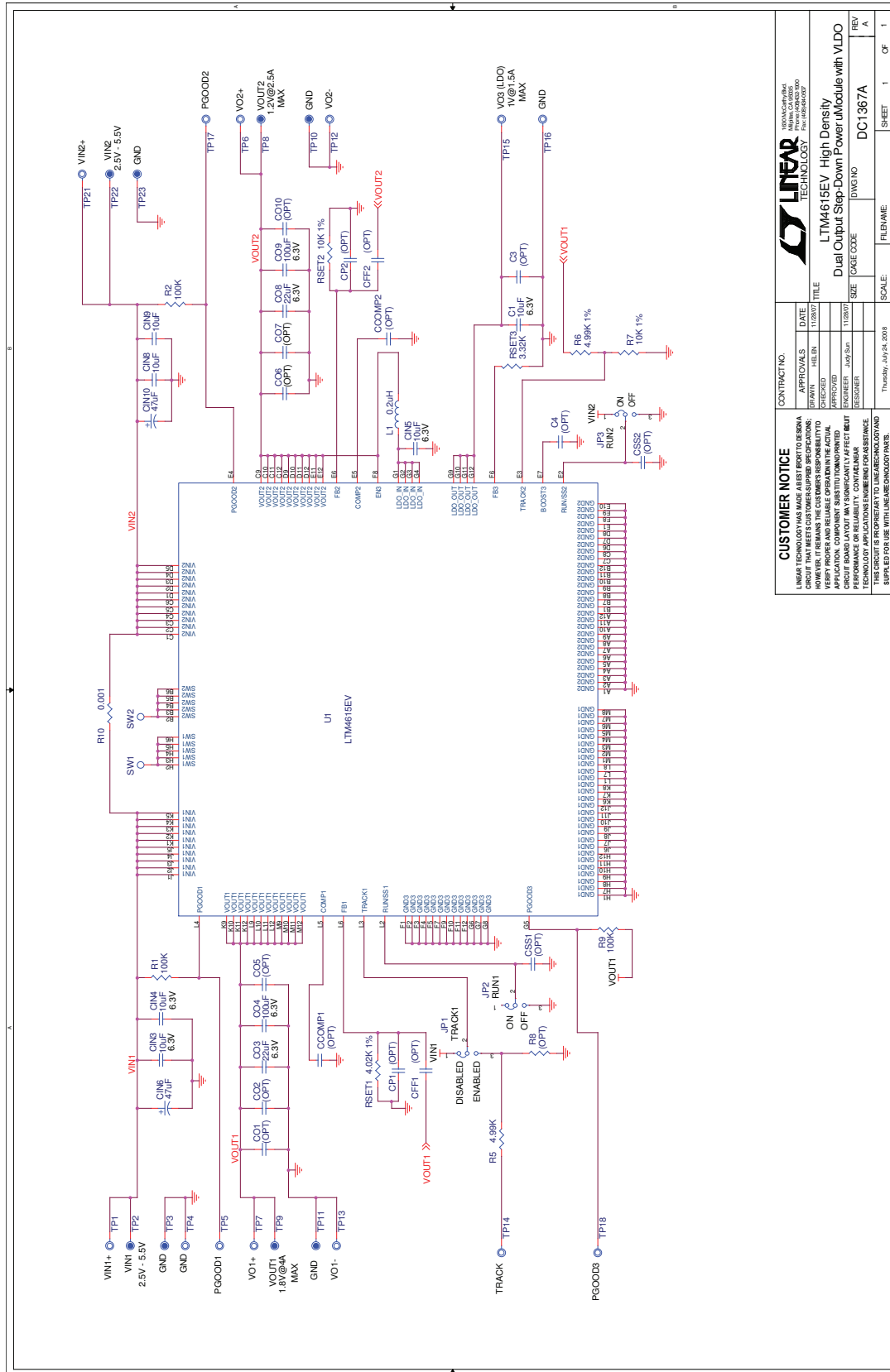

CUSTOMER NOTICE		CONTRACT NO.	DATE
LEADS FOR THIS BOARD ARE SUPPLIED AS A CIRCUIT THAT MEETS CUSTOMER-SPECIFIED SPECIFICATIONS. HOWEVER, IT REMAINS THE CUSTOMER'S RESPONSIBILITY TO VERIFY PROPER AND RELIABLE OPERATION WITH THE ACTUAL BOARD LAYOUT. A BOARD LAYOUT THAT SIGNIFICANTLY AFFECTS PERFORMANCE OR RELIABILITY, CONTAINING ANY CHANGES TO THE ORIGINAL BOARD LAYOUT, IS THE CUSTOMER'S RESPONSIBILITY. THE BOARD IS SUPPLIED FOR USE WITH LINEAR TECHNOLOGY PARTS.		APPROVALS	DATE
		DESIGNED BY	11/20/07
		CHECKED BY	
		APPROVED BY	
		ENGINEER	JAY/S/D
		DESIGNER	
		SIZE	TARGE CODE
		DWG NO.	DC1367A
		SCALE:	
		FILENAME:	
		SHEET	1 OF 1

DEMO MANUAL DC1367A

DEMONSTRATION BOARD IMPORTANT NOTICE

Linear Technology Corporation (LTC) provides the enclosed product(s) under the following **AS IS** conditions:

This demonstration board (DEMO BOARD) kit being sold or provided by Linear Technology is intended for use for **ENGINEERING DEVELOPMENT OR EVALUATION PURPOSES ONLY** and is not provided by LTC for commercial use. As such, the DEMO BOARD herein may not be complete in terms of required design-, marketing-, and/or manufacturing-related protective considerations, including but not limited to product safety measures typically found in finished commercial goods. As a prototype, this product does not fall within the scope of the European Union directive on electromagnetic compatibility and therefore may or may not meet the technical requirements of the directive, or other regulations.

If this evaluation kit does not meet the specifications recited in the DEMO BOARD manual the kit may be returned within 30 days from the date of delivery for a full refund. **THE FOREGOING WARRANTY IS THE EXCLUSIVE WARRANTY MADE BY THE SELLER TO BUYER AND IS IN LIEU OF ALL OTHER WARRANTIES, EXPRESSED, IMPLIED, OR STATUTORY, INCLUDING ANY WARRANTY OF MERCHANTABILITY OR FITNESS FOR ANY PARTICULAR PURPOSE. EXCEPT TO THE EXTENT OF THIS INDEMNITY, NEITHER PARTY SHALL BE LIABLE TO THE OTHER FOR ANY INDIRECT, SPECIAL, INCIDENTAL, OR CONSEQUENTIAL DAMAGES.**

The user assumes all responsibility and liability for proper and safe handling of the goods. Further, the user releases LTC from all claims arising from the handling or use of the goods. Due to the open construction of the product, it is the user's responsibility to take any and all appropriate precautions with regard to electrostatic discharge. Also be aware that the products herein may not be regulatory compliant or agency certified (FCC, UL, CE, etc.).

No License is granted under any patent right or other intellectual property whatsoever. **LTC assumes no liability for applications assistance, customer product design, software performance, or infringement of patents or any other intellectual property rights of any kind.**

LTC currently services a variety of customers for products around the world, and therefore this transaction **is not exclusive**.

Please read the DEMO BOARD manual prior to handling the product. Persons handling this product must have electronics training and observe good laboratory practice standards. **Common sense is encouraged.**

This notice contains important safety information about temperatures and voltages. For further safety concerns, please contact a LTC application engineer.

Mailing Address:

Linear Technology
1630 McCarthy Blvd.
Milpitas, CA 95035

Copyright © 2004, Linear Technology Corporation