





Grayhill, Inc.

62S11-N2-PH

Osa numero:	62S11-N2-PH
Valmistaja / merkki:	Grayhill, Inc.
Tuotteen Kuvaus	ROTARY ENCODER OPTICAL 32PPR
lomakkeissa:	 62S11-N2-PH.pdf
RoHS-tila	 Lyijytön / RoHS-yhteensopiva
Varaston kunto	1760 pcs stock
Lähetys	Hong Kong
Lähetysreitti	DHL/Fedex/TNT/UPS/EMS

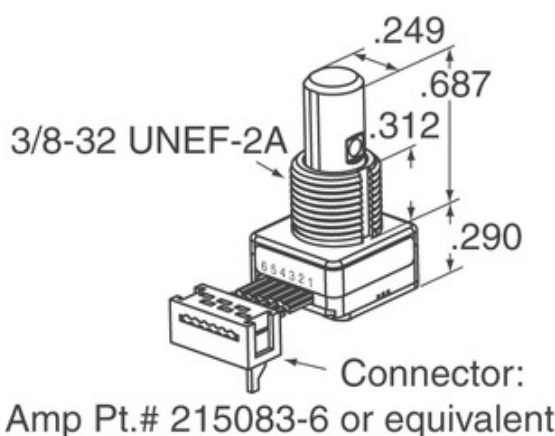
TARJOUSPYINTÖ

Kuva voi olla edustus. Katso tuotetiedot.



62S11-N2-PH: n tekniset tiedot

OSA NUMERO	62S11-N2-PH
VALMISTAJA	Grayhill, Inc.
KUVAUS	ROTARY ENCODER OPTICAL 32PPR
LYIJYTÖN TILA / ROHS-TILA	Lyijytön / RoHS-yhteensopiva
SAATAVANA OLEVA MÄÄRÄ	1760 pcs
TIELOLOMAKE	 62S11-N2-PH.pdf
JÄNNITE - SUPPLY	5V
PÄÄTTYMINEN STYLE	PC Pin
SARJA	62S
PYÖRITYKSEN LIFE (CYCLES MIN)	1M
PULSSIA PER KIERROS	32
LÄHTÖ TYYPPI	Quadrature (Incremental)
MUUT NIMET	62S11N2PH
SUUNTAUTUMINEN	Vertical
ASENNUSTYYPPI	PCB, Through Hole
KOSTEUDEN HERKKYYS (MSL)	1 (Unlimited)
LYIJYTÖN TILA / ROHS-TILA	Lead free / RoHS Compliant
ENCODER TYPE	Optical
PIDÄKKEEN	No
SISÄÄNRAKENNETTU KYTKIN	Yes
ACTUATOR TYPE	1/4" Dia Flatted End

Liittyvät tunnisteet

Grayhill, Inc. 62S11-N2-PH	62S11-N2-PH Jakelija	62S11-N2-PH-toimittaja
62S11-N2-PH Hinta	62S11-N2-PH Kuvat	62S11-N2-PH Kuva
62S11-N2-PH PDF -datata	62S11-N2-PH Lataa tietosivu	62S11-N2-PH-tietosivu
62S11-N2-PH Varasto	Osta 62S11-N2-PH	Osta Grayhill, Inc. 62S11-N2-PH
Grayhill, Inc. 62S11-N2-PH	Grayhill, Inc. toimittaja	Grayhill, Inc. Jakelija
Grayhill, Inc. 62S11-N2-PH	Grayhill Inc. 62S11-N2-PH	

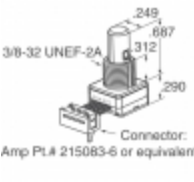
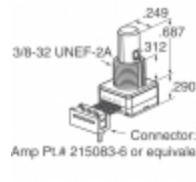
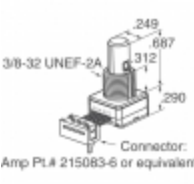
Liittyvät tuotteet

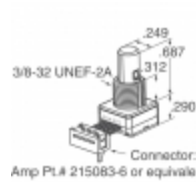
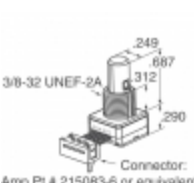
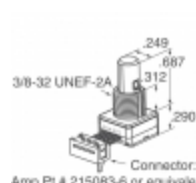
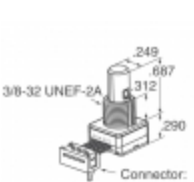
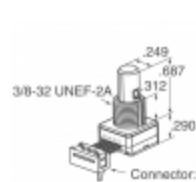
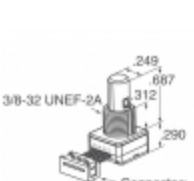
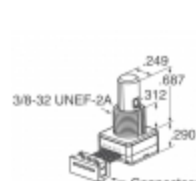
 <p>62S11-N4-060SH valmistajat: Grayhill, Inc. Kuvaus: ROTARY ENCODER OPTICAL 32PPR Varastossa: 2262 pcs</p> <p>RFQ</p>	 <p>62S11-N2-P valmistajat: Grayhill, Inc. Kuvaus: ROTARY ENCODER OPTICAL 32PPR Varastossa: 2376 pcs</p> <p>RFQ</p>
 <p>62S11-N3-PH valmistajat: Grayhill, Inc. Kuvaus: ROTARY ENCODER OPTICAL 32PPR Varastossa: 1856 pcs</p> <p>RFQ</p>	 <p>62S11-N4-020C valmistajat: Grayhill, Inc. Kuvaus: ROTARY ENCODER OPTICAL 32PPR Varastossa: 2083 pcs</p> <p>RFQ</p>
 <p>62S11-N4-025C valmistajat: Grayhill, Inc. Kuvaus: ROTARY ENCODER OPTICAL 32PPR Varastossa: 1970 pcs</p> <p>RFQ</p>	 <p>62S11-N2-030C valmistajat: Grayhill, Inc. Kuvaus: ROTARY ENCODER OPTICAL 32PPR Varastossa: 1773 pcs</p> <p>RFQ</p>
 <p>62S11-N0-PH valmistajat: Grayhill, Inc. Kuvaus: ROTARY ENCODER OPTICAL 32PPR Varastossa: 2260 pcs</p> <p>RFQ</p>	 <p>62S11-N4-120S valmistajat: Grayhill, Inc. Kuvaus: ROTARY ENCODER OPTICAL 32PPR Varastossa: 2038 pcs</p> <p>RFQ</p>
 <p>62S11-N4-025CH valmistajat: Grayhill, Inc. Kuvaus: ROTARY ENCODER OPTICAL 32PPR Varastossa: 1946 pcs</p> <p>RFQ</p>	 <p>62S11-N0-PHV valmistajat: Grayhill, Inc. Kuvaus: ROTARY ENCODER OPTICAL 32PPR Varastossa: 2020 pcs</p> <p>RFQ</p>
 <p>62S11-N0-P valmistajat: Grayhill, Inc. Kuvaus: ROTARY ENCODER OPTICAL 32PPR Varastossa: 2285 pcs</p> <p>RFQ</p>	 <p>62S11-N2-040C valmistajat: Grayhill, Inc. Kuvaus: ROTARY ENCODER OPTICAL 32PPR Varastossa: 2333 pcs</p> <p>RFQ</p>

Copyright © 2020 Elektronisten komponenttien luotettava jakelija

Sähköposti: Info@infinity-electronic.com

Osoite: 17F, Gaylord Commercial Building, 114-118 Lockhart Road, Wan Chai, Hong Kong

