





Grayhill, Inc.

62S11-N5-040C

Osa numero:	62S11-N5-040C
Valmistaja / merkki:	Grayhill, Inc.
Tuotteen Kuvaus	ROTARY ENCODER OPTICAL 32PPR
lomakkeissa:	 62S11-N5-040C.pdf
RoHS-tila	 Lyijytön / RoHS-yhteensopiva
Varaston kunto	2106 pcs stock
Lähetys	Hong Kong
Lähetysreitti	DHL/Fedex/TNT/UPS/EMS

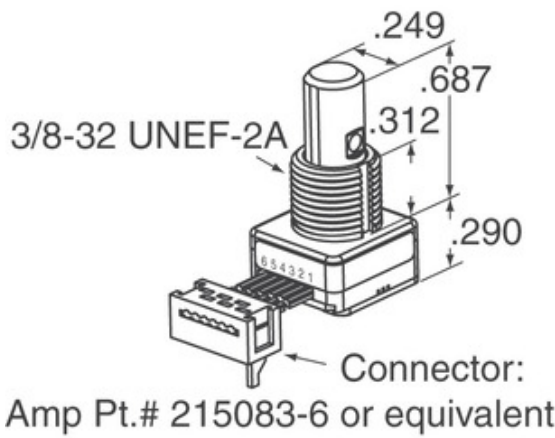
TARJOUSPYINTÖ

Kuva voi olla edustus. Katso tuotetiedot.





62S11-N5-040C: n tekniset tiedot

OSA NUMERO	62S11-N5-040C
VALMISTAJA	Grayhill, Inc.
KUVAUS	ROTARY ENCODER OPTICAL 32PPR
LYIJYTÖN TILA / ROHS-TILA	Lyijytön / RoHS-yhteensopiva
SAATAVANA OLEVA MÄÄRÄ	2106 pcs
TIELOLOMAKE	 62S11-N5-040C.pdf
JÄNNITE - SUPPLY	5V
PÄÄTTYMINEN STYLE	Cable with Connector
SARJA	62S
PYÖRITYKSEN LIFE (CYCLES MIN)	1M
PULSSIA PER KIERROS	32
LÄHTÖ TYYPPI	Quadrature (Incremental)
MUUT NIMET	62S11N5040C
SUUNTAUTUMINEN	Vertical
ASENNUSTYYPPI	Panel Mount
KOSTEUDEN HERKKYYS (MSL)	1 (Unlimited)
LYIJYTÖN TILA / ROHS-TILA	Lead free / RoHS Compliant
ENCODER TYPE	Optical
PIDÄKKEEN	No
SISÄÄNRAKENNETTU KYTKIN	Yes
ACTUATOR TYPE	1/4" Dia Flatted End

Liittyvät tunnisteet

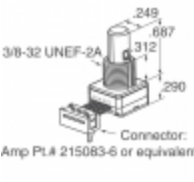
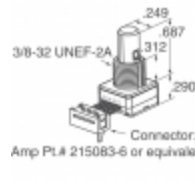
Grayhill, Inc. 62S11-N5-040C	62S11-N5-040C Jakelija	62S11-N5-040C-toimittaja
62S11-N5-040C Hinta	62S11-N5-040C Kuvat	62S11-N5-040C Kuva
62S11-N5-040C PDF -datata	62S11-N5-040C Lataa tietosivu	62S11-N5-040C-tietosivu
62S11-N5-040C Varasto	Osta 62S11-N5-040C	Osta Grayhill, Inc. 62S11-N5-040C
Grayhill, Inc. 62S11-N5-040C	Grayhill, Inc. toimittaja	Grayhill, Inc. Jakelija
Grayhill, Inc. 62S11-N5-040C	Grayhill Inc. 62S11-N5-040C	

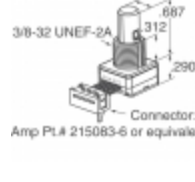
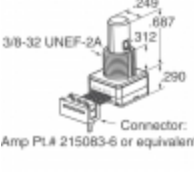
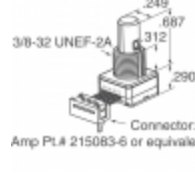
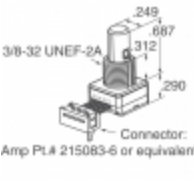
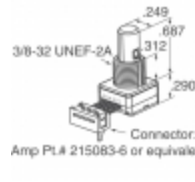
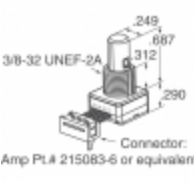
Liittyvät tuotteet

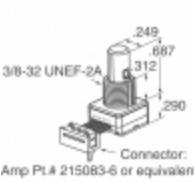
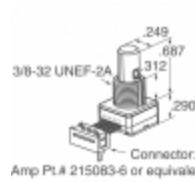
 <p>62S11-N4-060SH valmistajat: Grayhill, Inc. Kuvaus: ROTARY ENCODER OPTICAL 32PPR Varastossa: 2262 pcs</p> <p>RFQ</p>	 <p>62S11-N5-060SH valmistajat: Grayhill, Inc. Kuvaus: ROTARY ENCODER OPTICAL 32PPR Varastossa: 2263 pcs</p> <p>RFQ</p>
 <p>62S11-N5-025CH valmistajat: Grayhill, Inc. Kuvaus: ROTARY ENCODER OPTICAL 32PPR Varastossa: 2083 pcs</p> <p>RFQ</p>	 <p>62S11-N4-P valmistajat: Grayhill, Inc. Kuvaus: ROTARY ENCODER OPTICAL 32PPR Varastossa: 1912 pcs</p> <p>RFQ</p>
 <p>62S11-N5-060C valmistajat: Grayhill, Inc. Kuvaus: ROTARY ENCODER OPTICAL 32PPR Varastossa: 2164 pcs</p> <p>RFQ</p>	 <p>62S11-N4-120S valmistajat: Grayhill, Inc. Kuvaus: ROTARY ENCODER OPTICAL 32PPR Varastossa: 2038 pcs</p> <p>RFQ</p>
 <p>62S11-N5-050C valmistajat: Grayhill, Inc. Kuvaus: ROTARY ENCODER OPTICAL 32PPR Varastossa: 1936 pcs</p> <p>RFQ</p>	 <p>62S11-N5-080SH valmistajat: Grayhill, Inc. Kuvaus: ROTARY ENCODER OPTICAL 32PPR Varastossa: 1942 pcs</p> <p>RFQ</p>
 <p>62S11-N5-120S valmistajat: Grayhill, Inc. Kuvaus: ROTARY ENCODER OPTICAL 32PPR Varastossa: 1675 pcs</p> <p>RFQ</p>	 <p>62S11-N5-025C valmistajat: Grayhill, Inc. Kuvaus: ROTARY ENCODER OPTICAL 32PPR Varastossa: 2408 pcs</p> <p>RFQ</p>
 <p>62S11-N5-100C valmistajat: Grayhill, Inc. Kuvaus: ROTARY ENCODER OPTICAL 32PPR Varastossa: 1789 pcs</p> <p>RFQ</p>	 <p>62S11-N4-PH valmistajat: Grayhill, Inc. Kuvaus: ROTARY ENCODER OPTICAL 32PPR Varastossa: 1970 pcs</p> <p>RFQ</p>

Copyright © 2020 Elektronisten komponenttien luotettava jakelija

Sähköposti: Info@infinity-electronic.com

Osoite: 17F, Gaylord Commercial Building, 114-118 Lockhart Road, Wan Chai, Hong Kong

