

Panasonic

Panasonic

HE1AN-P-DC9V-H18

Osa numero:

HE1AN-P-DC9V-H18

Valmistaja / merkki:

Panasonic

Tuotteen Kuvaus

HE RELAYS 1 FORM A 9VDC

lomakkeissa:

 HE1AN-P-DC9V-H18.pdf

RoHS-tila

 Lyijytön / RoHS-yhteensopiva

Varaston kunto

4621 pcs stock

Lähetys

Hong Kong

Lähetysreitti

DHL/Fedex/TNT/UPS/EMS

TARJOUSPYYNTÖ

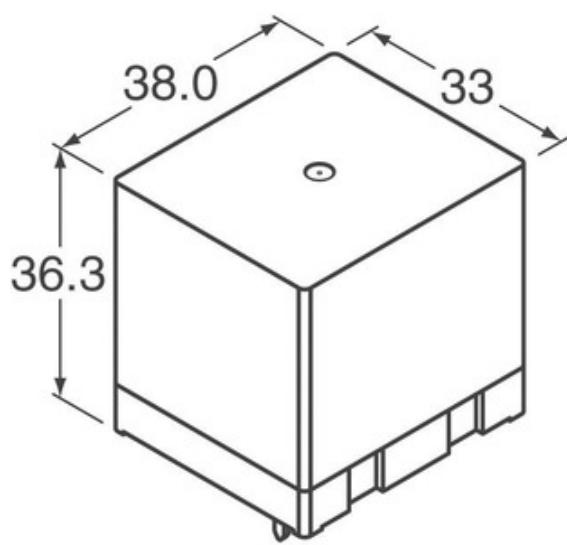

Kuva voi olla edustus. Katso tuotetiedot.











HE1AN-P-DC9V-H18: n tekniset tiedot

OSA NUMERO	HE1AN-P-DC9V-H18
VALMISTAJA	Panasonic
KUVAUS	HE RELAYS 1 FORM A 9VDC
LYIJYTÖN TILA / ROHS-TILA	Lyijytön / RoHS-yhteensopiva
SAATAVANA OLEVA MÄÄRÄ	4621 pcs
TIELOLOMAKE	 HE1AN-P-DC9V-H18.pdf
SARJA	*
KOSTEUDEN HERKKYYS (MSL)	1 (Unlimited)
LYIJYTÖN TILA / ROHS-TILA	Lead free / RoHS Compliant
YKSITYISKOHTAINEN KUVAUS	Relay Coil

Liittyvät tunnisteet

Panasonic HE1AN-P-DC9V-H18	HE1AN-P-DC9V-H18 Jakelija	HE1AN-P-DC9V-H18-toimittaja
HE1AN-P-DC9V-H18 Hinta	HE1AN-P-DC9V-H18 Kuvat	HE1AN-P-DC9V-H18 Kuva
HE1AN-P-DC9V-H18 PDF -datata	HE1AN-P-DC9V-H18 Lataa tietosivu	HE1AN-P-DC9V-H18-tietosivu
HE1AN-P-DC9V-H18 Varasto	Osta HE1AN-P-DC9V-H18	Osta Panasonic HE1AN-P-DC9V-H18
Panasonic HE1AN-P-DC9V-H18	Panasonic toimittaja	Panasonic Jakelija
Panasonic HE1AN-P-DC9V-H18	Panasonic - Consumer Division HE1AN-P-DC9V-H18	Panasonic - Consumer Electronics Corp. HE1AN-P-DC9V-H18
Panasonic Battery Group HE1AN-P-DC9V-H18	Panasonic Electric Works - ACSD HE1AN-P-DC9V-H18	Panasonic Electronic Components - Semiconductor Pr HE1AN-P-DC9V-H18
Panasonic - ATG HE1AN-P-DC9V-H18	Panasonic - BSG HE1AN-P-DC9V-H18	Panasonic - DTG HE1AN-P-DC9V-H18
Panasonic Electric Works HE1AN-P-DC9V-H18	Panasonic Electronic Components HE1AN-P-DC9V-H18	Panasonic Industrial Automation Sales HE1AN-P-DC9V-H18
Panasonic Semiconductor HE1AN-P-DC9V-H18		

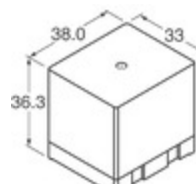
Liittyvät tuotteet

 <p>HE1AN-Q-AC24V valmistajat: Panasonic Kuvaus: RELAY GEN PURPOSE SPST 30A 24V Varastossa: 3984 pcs</p> <p>RFQ</p>	 <p>HE1AN-Q-AC240V valmistajat: Panasonic Kuvaus: RELAY GEN PURPOSE SPST 30A 240V Varastossa: 4724 pcs</p> <p>RFQ</p>
 <p>HE1AN-Q-AC12V valmistajat: Panasonic Kuvaus: RELAY GEN PURPOSE SPST 30A 12V Varastossa: 3671 pcs</p> <p>RFQ</p>	 <p>HE1AN-P-DC24V valmistajat: Panasonic Kuvaus: RELAY GEN PURPOSE SPST 30A 24V Varastossa: 5103 pcs</p> <p>RFQ</p>
 <p>HE1AN-P-DC48V valmistajat: Panasonic Kuvaus: RELAY GEN PURPOSE SPST 30A 48V Varastossa: 4726 pcs</p> <p>RFQ</p>	 <p>HE1AN-P-DC12V-Y5 valmistajat: Panasonic Kuvaus: RELAY GEN PURPOSE SPST 48A 12V Varastossa: 2508 pcs</p> <p>RFQ</p>
 <p>HE1AN-P-DC6V-Y5 valmistajat: Panasonic Kuvaus: RELAY GEN PURPOSE SPST 48A 6V Varastossa: 2679 pcs</p> <p>RFQ</p>	 <p>HE1AN-P-DC9V-Y5 valmistajat: Panasonic Kuvaus: RELAY GEN PURPOSE SPST 48A 9V Varastossa: 2911 pcs</p> <p>RFQ</p>
 <p>HE1AN-Q-AC120V valmistajat: Panasonic Kuvaus: RELAY GEN PURPOSE SPST 30A 120V Varastossa: 4652 pcs</p> <p>RFQ</p>	 <p>HE1AN-P-DC9V-Y4 valmistajat: Panasonic Kuvaus: HE RELAYS 1 FORM A 9VDC Varastossa: 4805 pcs</p> <p>RFQ</p>
 <p>HE1AN-P-DC24V-Y5 valmistajat: Panasonic Kuvaus: RELAY GEN PURPOSE SPST 48A 24V Varastossa: 2622 pcs</p> <p>RFQ</p>	 <p>HE1AN-P-DC12V-H18 valmistajat: Panasonic Kuvaus: RELAY GEN PURPOSE SPST 35A 12V Varastossa: 6470 pcs</p> <p>RFQ</p>

Copyright © 2020 Elektronisten komponenttien luotettava jakelija

Sähköposti: Info@infinity-electronic.com

Osoite: 17F, Gaylord Commercial Building, 114-118 Lockhart Road, Wan Chai, Hong Kong

