





Grayhill, Inc.

62S11-H0-020S

Osa numero:	62S11-H0-020S
Valmistaja / merkki:	Grayhill, Inc.
Tuotteen Kuvaus	ROTARY ENCODER OPTICAL 32PPR
lomakkeissa:	 62S11-H0-020S.pdf
RoHS-tila	 Lyijytön / RoHS-yhteensopiva
Varaston kunto	1990 pcs stock
Lähetys	Hong Kong
Lähetysreitti	DHL/Fedex/TNT/UPS/EMS

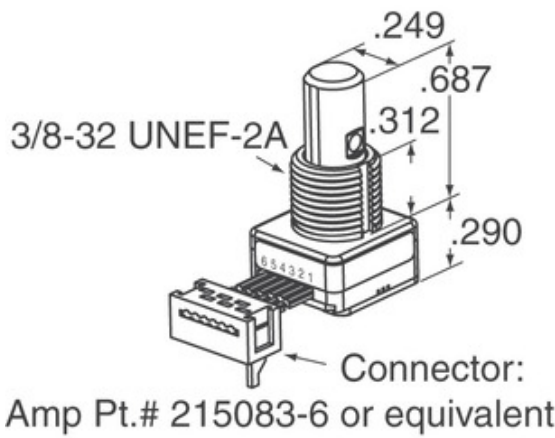
TARJOUSPYINTÖ

Kuva voi olla edustus. Katso tuotetiedot.





62S11-H0-020S: n tekniset tiedot

OSA NUMERO	62S11-H0-020S
VALMISTAJA	Grayhill, Inc.
KUVAUS	ROTARY ENCODER OPTICAL 32PPR
LYIJYTÖN TILA / ROHS-TILA	Lyijytön / RoHS-yhteensopiva
SAATAVANA OLEVA MÄÄRÄ	1990 pcs
TIELOMAKE	 62S11-H0-020S.pdf
JÄNNITE - SUPPLY	5V
PÄÄTTYMINEN STYLE	Cable Leads
SARJA	62S
PYÖRITYKSEN LIFE (CYCLES MIN)	1M
PULSSIA PER KIERROS	32
LÄHTÖ TYYPPI	Quadrature (Incremental)
MUUT NIMET	62S11H0020S
SUUNTAUTUMINEN	Vertical
ASENNUSTYYPPI	Panel Mount
KOSTEUDEN HERKKYYS (MSL)	1 (Unlimited)
LYIJYTÖN TILA / ROHS-TILA	Lead free / RoHS Compliant
ENCODER TYPE	Optical
PIDÄKKEEN	Yes
SISÄÄNRAKENNETTU KYTKIN	No
ACTUATOR TYPE	1/4" Dia Flatted End

Liittyvät tunnisteet

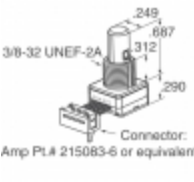
Grayhill, Inc. 62S11-H0-020S	62S11-H0-020S Jakelija	62S11-H0-020S-toimittaja
62S11-H0-020S Hinta	62S11-H0-020S Kuvat	62S11-H0-020S Kuva
62S11-H0-020S PDF -datata	62S11-H0-020S Lataa tietosivu	62S11-H0-020S-tietosivu
62S11-H0-020S Varasto	Osta 62S11-H0-020S	Osta Grayhill, Inc. 62S11-H0-020S
Grayhill, Inc. 62S11-H0-020S	Grayhill, Inc. toimittaja	Grayhill, Inc. Jakelija
Grayhill, Inc. 62S11-H0-020S	Grayhill Inc. 62S11-H0-020S	

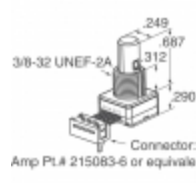
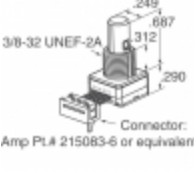
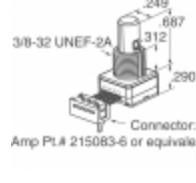
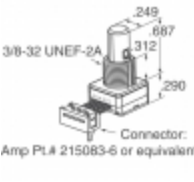
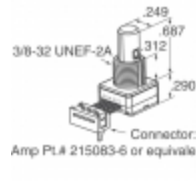
Liittyvät tuotteet

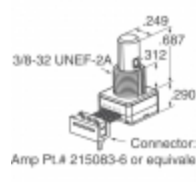
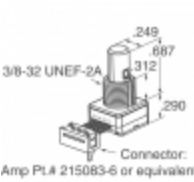
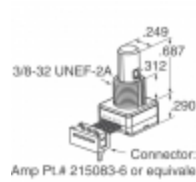
 <p>62S11-H9-040C valmistajat: Grayhill, Inc. Kuvaus: ROTARY ENCODER OPTICAL 32PPR Varastossa: 1975 pcs</p> <p>RFQ</p>	 <p>62S11-H0-040C valmistajat: Grayhill, Inc. Kuvaus: ROTARY ENCODER OPT 32PPR 2" CBL Varastossa: 2505 pcs</p> <p>RFQ</p>
 <p>62S11-H0-030C valmistajat: Grayhill, Inc. Kuvaus: ROTARY ENCODER OPT 32PPR 2" CBL Varastossa: 2314 pcs</p> <p>RFQ</p>	 <p>62S11-H9-020C valmistajat: Grayhill, Inc. Kuvaus: ROTARY ENCODER OPTICAL 32PPR Varastossa: 2176 pcs</p> <p>RFQ</p>
 <p>62S11-H9-025S valmistajat: Grayhill, Inc. Kuvaus: ROTARY ENCODER OPTICAL 32PPR Varastossa: 2155 pcs</p> <p>RFQ</p>	 <p>62S11-H0-020C valmistajat: Grayhill, Inc. Kuvaus: ROTARY ENCODER OPTICAL 32PPR Varastossa: 2219 pcs</p> <p>RFQ</p>
 <p>62S11-H0-PH valmistajat: Grayhill, Inc. Kuvaus: ROTARY ENCODER OPTICAL 32PPR Varastossa: 2006 pcs</p> <p>RFQ</p>	 <p>62S11-H0-060C valmistajat: Grayhill, Inc. Kuvaus: ROTARY ENCODER OPTICAL 32PPR Varastossa: 2181 pcs</p> <p>RFQ</p>
 <p>62S11-H0-P valmistajat: Grayhill, Inc. Kuvaus: ROTARY ENCODER OPT 32PPR 10" CBL Varastossa: 2508 pcs</p> <p>RFQ</p>	 <p>62S11-H0-200S valmistajat: Grayhill, Inc. Kuvaus: ROTARY ENCODER OPTICAL 32PPR Varastossa: 1933 pcs</p> <p>RFQ</p>
 <p>62S11-H0-060SH valmistajat: Grayhill, Inc. Kuvaus: ROTARY ENCODER OPTICAL 32PPR Varastossa: 2339 pcs</p> <p>RFQ</p>	 <p>62S11-H9-020S valmistajat: Grayhill, Inc. Kuvaus: ROTARY ENCODER OPTICAL 32PPR Varastossa: 2170 pcs</p> <p>RFQ</p>

Copyright © 2020 Elektronisten komponenttien luotettava jakelija

Sähköposti: Info@infinity-electronic.com

Osoite: 17F, Gaylord Commercial Building, 114-118 Lockhart Road, Wan Chai, Hong Kong

