

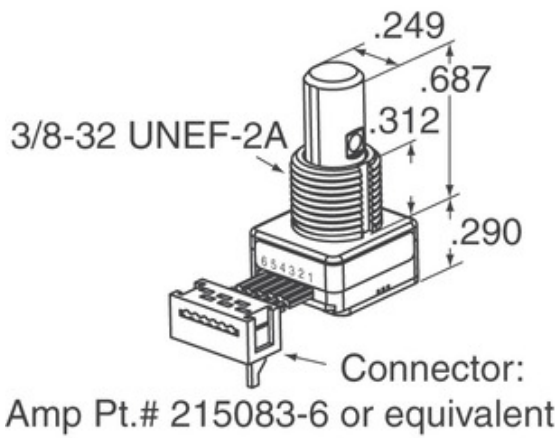

Grayhill, Inc.

## 62S11-N9-060C

Osa numero:	62S11-N9-060C
Valmistaja / merkki:	Grayhill, Inc.
Tuotteen Kuvaus	ROTARY ENCODER OPTICAL 32PPR
lomakkeissa:	 62S11-N9-060C.pdf
RoHS-tila	 Lyijytön / RoHS-yhteensopiva
Varaston kunto	2192 pcs stock
Lähetys	Hong Kong
Lähetysreitti	DHL/Fedex/TNT/UPS/EMS

**TARJOUSPYINTÖ**

Kuva voi olla edustus. Katso tuotetiedot.







### 62S11-N9-060C: n tekniset tiedot

OSA NUMERO	62S11-N9-060C
VALMISTAJA	Grayhill, Inc.
KUVAUS	ROTARY ENCODER OPTICAL 32PPR
LYIJYTÖN TILA / ROHS-TILA	Lyijytön / RoHS-yhteensopiva
SAATAVANA OLEVA MÄÄRÄ	2192 pcs
TIELOLOMAKE	 62S11-N9-060C.pdf
JÄNNITE - SUPPLY	5V
PÄÄTTYMINEN STYLE	Cable with Connector
SARJA	62S
PYÖRITYKSEN LIFE (CYCLES MIN)	1M
PULSSIA PER KIERROS	32
LÄHTÖ TYYPPI	Quadrature (Incremental)
MUUT NIMET	62S11N9060C
SUUNTAUTUMINEN	Vertical
ASENNUSTYYPPI	Panel Mount
KOSTEUDEN HERKKYYS (MSL)	1 (Unlimited)
LYIJYTÖN TILA / ROHS-TILA	Lead free / RoHS Compliant
ENCODER TYPE	Optical
PIDÄKKEEN	No
SISÄÄNRAKENNETTU KYTKIN	Yes
ACTUATOR TYPE	1/4" Dia Flatted End

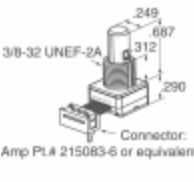
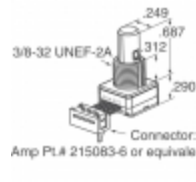
### Liittyvät tunnisteet

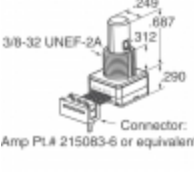
Grayhill, Inc. 62S11-N9-060C	62S11-N9-060C Jakelija	62S11-N9-060C-toimittaja
62S11-N9-060C Hinta	62S11-N9-060C Kuvat	62S11-N9-060C Kuva
62S11-N9-060C PDF -datata	62S11-N9-060C Lataa tietosivu	62S11-N9-060C-tietosivu
62S11-N9-060C Varasto	Osta 62S11-N9-060C	Osta Grayhill, Inc. 62S11-N9-060C
Grayhill, Inc. 62S11-N9-060C	Grayhill, Inc. toimittaja	Grayhill, Inc. Jakelija
Grayhill, Inc. 62S11-N9-060C	Grayhill Inc. 62S11-N9-060C	

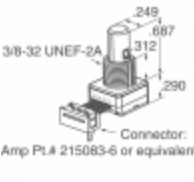
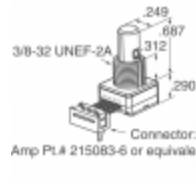
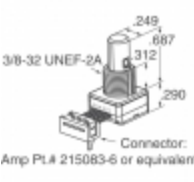
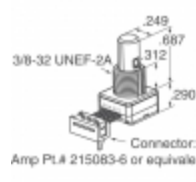
### Liittyvät tuotteet

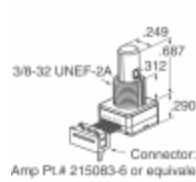
 <p><b>62S11-N5-060SH</b> valmistajat: Grayhill, Inc. Kuvaus: ROTARY ENCODER OPTICAL 32PPR Varastossa: 2263 pcs</p> <p><b>RFQ</b></p>	 <p><b>62S11-N9-060SH</b> valmistajat: Grayhill, Inc. Kuvaus: ROTARY ENCODER OPTICAL 32PPR Varastossa: 1801 pcs</p> <p><b>RFQ</b></p>
 <p><b>62S15-H0-020C</b> valmistajat: Grayhill, Inc. Kuvaus: ROTARY ENCODER OPTICAL 24PPR Varastossa: 2286 pcs</p> <p><b>RFQ</b></p>	 <p><b>62S15-H0-040CH</b> valmistajat: Grayhill, Inc. Kuvaus: ROTARY ENCODER OPTICAL 24PPR Varastossa: 1921 pcs</p> <p><b>RFQ</b></p>
 <p><b>62S11-N5-080SH</b> valmistajat: Grayhill, Inc. Kuvaus: ROTARY ENCODER OPTICAL 32PPR Varastossa: 1942 pcs</p> <p><b>RFQ</b></p>	 <p><b>62S11-N5-PV</b> valmistajat: Grayhill, Inc. Kuvaus: ROTARY ENCODER OPTICAL 32PPR Varastossa: 2220 pcs</p> <p><b>RFQ</b></p>
 <p><b>62S11-N9-PH</b> valmistajat: Grayhill, Inc. Kuvaus: ROTARY ENCODER OPTICAL 32PPR Varastossa: 2219 pcs</p> <p><b>RFQ</b></p>	 <p><b>62S11-N5-100C</b> valmistajat: Grayhill, Inc. Kuvaus: ROTARY ENCODER OPTICAL 32PPR Varastossa: 1789 pcs</p> <p><b>RFQ</b></p>
 <p><b>62S11-N9-120S</b> valmistajat: Grayhill, Inc. Kuvaus: ROTARY ENCODER OPTICAL 32PPR Varastossa: 1784 pcs</p> <p><b>RFQ</b></p>	 <p><b>62S11-N5-120S</b> valmistajat: Grayhill, Inc. Kuvaus: ROTARY ENCODER OPTICAL 32PPR Varastossa: 1675 pcs</p> <p><b>RFQ</b></p>
 <p><b>62S15-H0-040C</b> valmistajat: Grayhill, Inc. Kuvaus: ROTARY ENCODER OPTICAL 24PPR Varastossa: 1793 pcs</p> <p><b>RFQ</b></p>	 <p><b>62S11-N5-P</b> valmistajat: Grayhill, Inc. Kuvaus: ROTARY ENCODER OPTICAL 32PPR Varastossa: 1885 pcs</p> <p><b>RFQ</b></p>

Copyright © 2020 Elektronisten komponenttien luotettava jakelija

Sähköposti: Info@infinity-electronic.com

Osoite: 17F, Gaylord Commercial Building, 114-118 Lockhart Road, Wan Chai, Hong Kong

